

*Made for hard work*



🇬🇧 Product catalog 2023



Mølbros Production manufactures quality soil tillage parts at the factory in Denmark, just as we have done since 1947. Our Products are today sold in large parts of the world, so our products are on the shelf when you need them.



**“An implement is  
only as good as  
its wear parts”**

© Copyright MØLBRO PRODUCTIONS 2023  
EUROSHARE ® Registered design, Utility model registered  
EUROPOINT ® Registered design, Utility model registered  
MØLBRO ®  
MØLBRO M7-point and MØLBRO M7-adapter protected by  
US patent no.8875424

## Plough parts

AGROLUX AH ploughbody	5
AGROLUX AS ploughbody	6
AGROLUX AX ploughbody	7
AGROLUX FC ploughbody	8
AGROLUX FK ploughbody	9
AGROLUX KHN ploughbody	10
AGROLUX KH ploughbody	10
AGROLUX L, P and PP ploughbody	10
AGROLUX UX ploughbody	11
DURO	12
DOWDESWELL DD ploughbody	12
DOWDESWELL RCN, SCN, UCN ploughbody	13
FORTSCHRITT 30Z and 30ZS ploughbody	14
FRAUGDE CAX ploughbody	15
FRAUGDE FK ploughbody	15
FRAUGDE FA ploughbody	16
FRAUGDE FA and FKA ploughbody	17
FRAUGDE FS and GS ploughbody	18
FRAUGDE MS ploughbody	19
FRAUGDE 208 ploughbody	20
FRAUGDE	21
GOIZIN	22
GREGOIRE-BESSON	23
KUHN RH/RLM ploughbody	24
KUHN PP and C	24
KUHN H4 and H6 ploughbody	25
KUHN HB4 and HB6 ploughbody	26
KUHN SK ploughbody	27
KUHN VL ploughbody	28
KUHN VS/N ploughbody	29
KUHN	29
KUHN T ploughbody	30
KVERN ELAND ploughbody Serie 53	31
KVERNELAND ploughbody no. 1 og 3	31
KVERNELAND ploughbody no. 8 og 9	32
KVERNELAND ploughbody no. 14	34
KVERNELAND ploughbody no. 28	35
KVERNELAND ploughbody no. 12 og 19	37
KVERNELAND ploughbody no. 20 og 30	39
KVERNELAND ploughbody ECOMAT	40
KVERNELAND	41
LEMKEN B ploughbody	42
LEMKEN BS 40 ploughbody	43
LEMKEN BS 42 ploughbody	44
LEMKEN BU ploughbody	45
LEMKEN CS Duramaxx ploughbody	45
LEMKEN	45
LEMKEN C and C40 ploughbody	46
LEMKEN US 35 ploughbody	47
LEMKEN US 40 ploughbody	48
LEMKEN WG ploughbody	49
LEMKEN OPAL ploughbody	49
LEMKEN WS ploughbody	49
NAUD	50
NIEMEYER	50
PÖTTINGER ploughbody 36W and 41W	51
PÖTTINGER ploughbody 46W	52
RABEWERK ploughbody BP-321, 322, 323 PS/PSL	53
RABEWERK ploughbody BP-350 WS/WSL	54
RABEWERK ploughbody BP-2930, 2940L	55
RABEWERK	56
RABEWERK universal ploughs (Lemken)	57
VOGEL & NOOT ploughbody UN400	58
VOGEL & NOOT	58
VOGEL & NOOT ploughbody WY 400	59
ÖVERUM SR ploughbody	60
ÖVERUM UC ploughbody	61
ÖVERUM V ploughbody	62
ÖVERUM XL ploughbody	63
ÖVERUM XS ploughbody	64
ÖVERUM XU ploughbody	65
ÖVERUM XLD	66
ÖVERUM	67
ÖVERUM SM, SML and SMK ploughbody	67

## Subsoiler parts

KVERNELAND subsoiler "S" model AGROMAT	69
KVERNELAND Bonator subsoiler	69
Standard subsoiler and harrows	69
USA standard subsoiler, CASE, NEW HOLLAND	70
Standard disc, KVERNELAND, HORSCH, FORTSCHRITT	71
HORSCH subsoiler	73
HORSCH subsoiler	74
BOURGAULT subsoiler	74
KÖCKERLING subsoiler and standard subsoiler	76
LEMKEN Smaragd / Topas subsoiler	77
LEMKEN Thorit / Achat subsoiler	77
LEMKEN Kristall / Karat subsoiler	78
LEMKEN subsoiler	78
LEMKEN-KOMPAKTOR	78
LEMKEN seed drill	78
VÅDERSTAD seed drill	79
VÅDERSTAD subsoiler	80
PÖTTINGER - seed drill	80
AMAZONE harrows	81

## Hubs for discs

KVERNELAND	84
VÅDERSTAD	84
ÖVERUM	85

## MØLBRO BK System

Bolts and nuts system	87
-----------------------	----



# How to read the catalogue

If you require bolts and nuts when you order your tillage parts, Mølbro is also able to deliver this. Mølbro supplies bolt kits with the exact content required for each tillage part. In our catalogue you will find, next to the article number, the Bolt Kit (BK) number to order. Please note that the bolt kits are to be ordered separately.

Brand/Manufacturer	Model	Section	Product no. / Article no.	Designation	Bolt kit matching product
<b>LEMKEN BS 42 ploughbody</b>					
<b>Mouldboards, shins and accessories</b>					
			<b>Article no.</b>	<b>Designation</b>	<b>BK. no.</b>
			3470860	Turbo-trashboard R	BK009
			3470861	Turbo-trashboard L	BK009
			469MOL-R	Stay with support R	BK141
			469MOL-L	Stay with support L	BK141
			567MOL	Support for stay, short	
			568MOL	Support for stay, long	
			3451002	Shin R (10mm)	BK007
			3451003	Shin L (10mm)	BK007
			<b>3451010</b>	<b>Shin R (8mm)</b>	<b>BK010</b>
			<b>3451011</b>	<b>Shin L (8mm)</b>	<b>BK010</b>
			3444010	Mouldboard stripe R	BK172
			3444011	Mouldboard stripe L	BK172
			3444020	Mouldboard stripe R	BK172
			3444021	Mouldboard stripe L	BK172
			3444030	Mouldboard stripe R	BK172
			3444031	Mouldboard stripe L	BK172
			3444040	Mouldboard stripe R	BK173
			3444041	Mouldboard stripe L	BK173
			3444012	Rev. top stripe R	BK006
			3444013	Rev. top stripe L	BK006
			4671002	Frog R	BK140
			4671003	Frog L	BK140
			4671010	Frog R	BK140
			4671011	Frog L	BK140

# Mølbros recommended torque

It is important that the recommended maximum torque is not exceeded. Avoid tightening the tillage part too hard as this can lead to damages. By use of power tools there is also a risk of overtightening which can damage your tillage parts.

## Recommendation - Plough

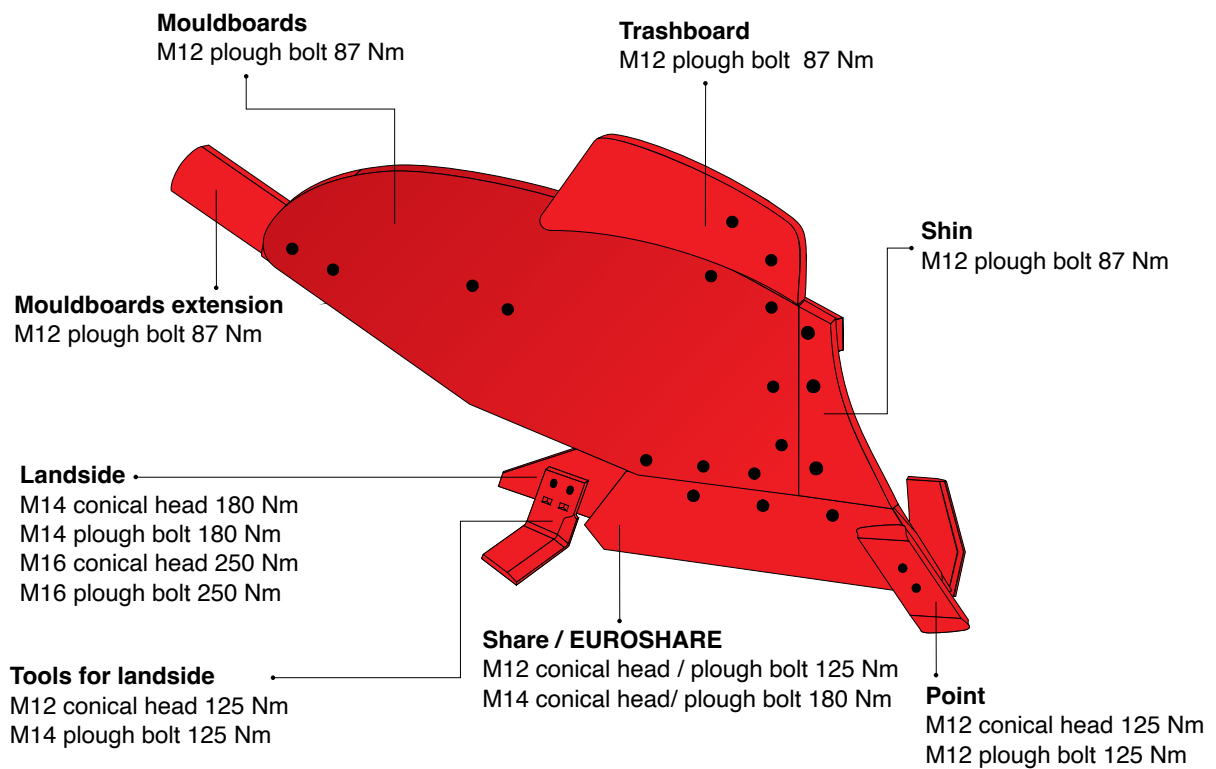

## Recommendation - Subsoiler

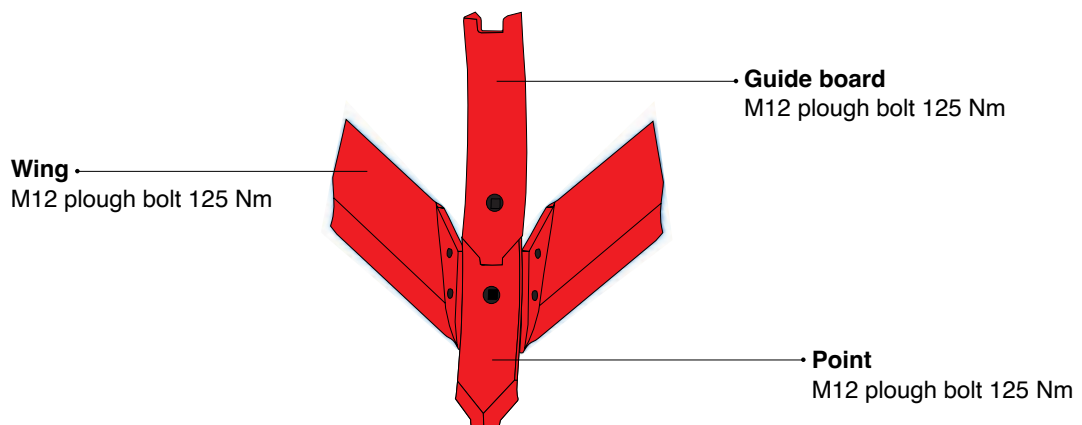

 The warranty may lapse if we find that a broken parts are due to the specified recommended torque being violently exceeded





**Plough parts**

Parts to fit:

# AGROLUX AH ploughbody

## Mouldboards, shins and accessories

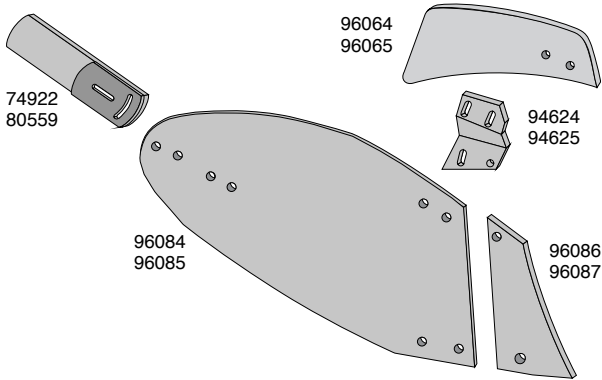

Article no.	Designation	BK. no.
74922	Mouldboard extension R	BK082
80559	Mouldboard extension L	BK082
96064/83969	Turbo-trashboard R	
96065/83968	Turbo -trashboard L	
94624	Fittings for trashboard R	BK082
94625	Fittings for trashboard L	BK082
96084	Mouldboard R	BK067
96085	Mouldboard L	BK067
96086	Shin R	BK052
96087	Shin L	BK052

## Share and points

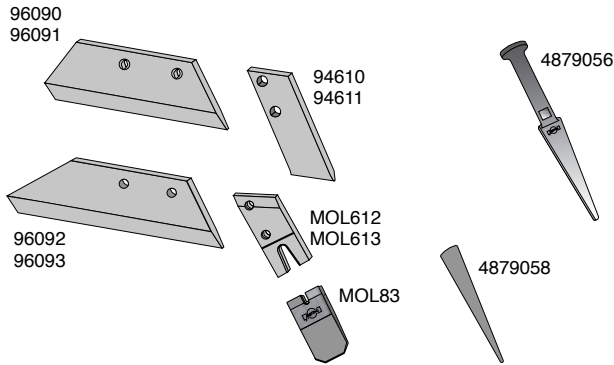

Article no.	Designation	BK. no.
96090	Share 16" R	BK052
96091	Share 16" L	BK052
96092	Share 18" R	BK052
96093	Share 18" L	BK052
94610	Europoint R	BK031
94611	Europoint L	BK031
MOL612	M7 adapter R	BK031
MOL613	M7 adapter L	BK031
MOL83	M7 point rev. R&L	
4879058	Wedge for M7 point	
4879056	Wedge for M7 point	

## Landsides and share knives

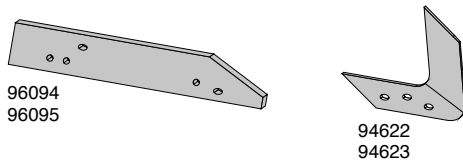

Article no.	Designation	BK. no.
96094	Landside R	BK069
96095	Landside L	BK069
94622	Share knife R	BK084
94623	Share knife L	BK084

## Parts to mount on landsides

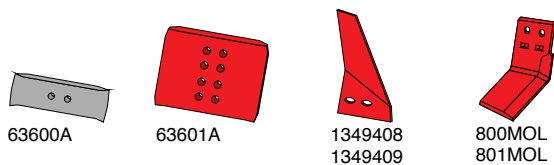

Article no.	Designation	BK. no.
63600A	Wearig plate, rev. R&L	BK094
63601A	Wearig plate, rev. R&L	BK094
1349408	Sword coulters R	BK052
1349409	Sword coulters L	BK052
800MOL	Subsoiler blade R	BK096
801MOL	Subsoiler blade L	BK096



Parts to fit:

# AGROLUX AS ploughbody

## Mouldboards, shins and accessories

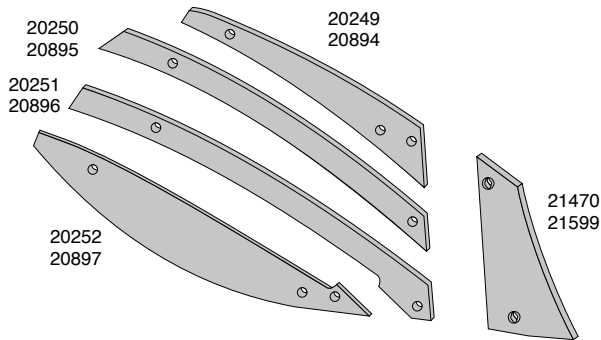

Article no.	Designation	BK. no.
20249	Mouldboard stripe R	BK058
20894	Mouldboard stripe L	BK058
20250	Mouldboard stripe R	BK052
20895	Mouldboard stripe L	BK052
20251	Mouldboard stripe R	BK052
20896	Mouldboard stripe L	BK052
20252	Mouldboard stripe R	BK058
20897	Mouldboard stripe L	BK058
21470	Shin R	BK052
21599	Shin L	BK052

## Share and points

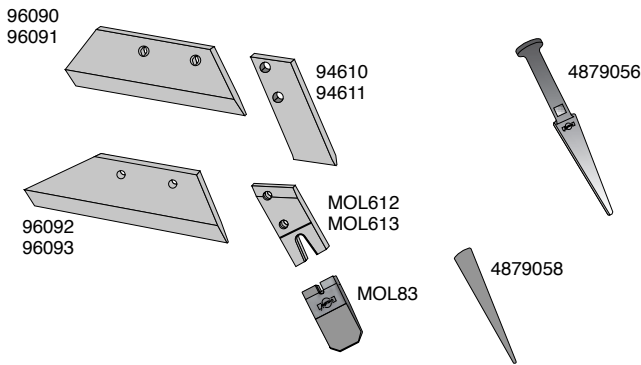

Article no.	Designation	BK. no.
96090	Share 16" R	BK052
96091	Share 16" L	BK052
96092	Share 18" R	BK052
96093	Share 18" L	BK052
94610	Europoint R	BK031
94611	Europoint L	BK031
MOL612	M7 adapter R	BK031
MOL613	M7 adapter L	BK031
MOL83	M7 point rev. R&L	
4879058	Wedge for M7 point	
4879056	Wedge for M7 point	

## Landsides and share knives

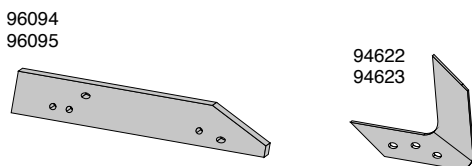

Article no.	Designation	BK. no.
96094	Landside R	BK069
96095	Landside L	BK069
94622	Share knife R	BK084
94623	Share knife L	BK084

## Parts to mount on landsides

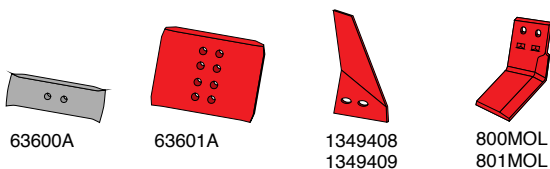

Article no.	Designation	BK. no.
63600A	Wearing plate, rev. R&L	BK094
63601A	Wearing plate, rev. R&L	BK094
1349408	Sword coulter R	BK052
1349409	Sword coulter L	BK052
800MOL	Subsoiler blade R	BK096
801MOL	Subsoiler blade L	BK096

**Do you know...**  
 Your landside last three to four times longer if you use Molbro's wearing plates 63600A or 63601A?



Parts to fit:

# AGROLUX AX ploughbody

## Mouldboards, shins and accessories

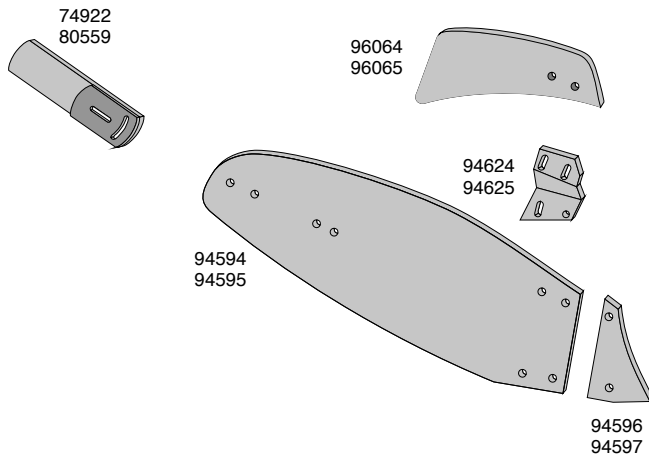

Article no.	Designation	BK. no.
74922	Mouldboard extension R	BK082
80559	Mouldboard extension L	BK082
96064	Turbo-trashboard R	BK167
96065	Turbo-trashboard L	BK167
94624	Fittings for trashboard R	BK082
94625	Fittings for trashboard L	BK082
94594	Mouldboard R	BK066
94595	Mouldboard L	BK066
94596	Shin R	BK052
94597	Shin L	BK052

## Share and points

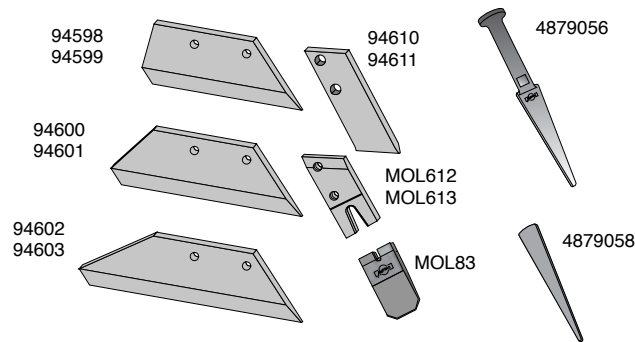

Article no.	Designation	BK. no.
94598	Share 14" R	BK052
94599	Share 14" L	BK052
94600	Share 16" R	BK052
94601	Share 16" L	BK052
94602	Share 18" R	BK052
94603	Share 18" L	BK052
94610	Europoint R	BK031
94611	Europoint L	BK031
MOL612	M7 adapter R	BK031
MOL613	M7 adapter L	BK031
MOL83	M7 point rev. R&L	
4879058	Wedge for M7 point	
4879056	Wedge for M7 point	

## Landsides and share knives

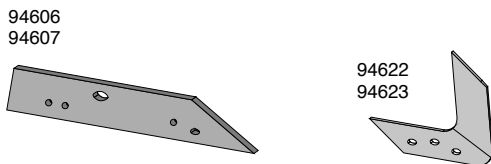

Article no.	Designation	BK. no.
94606	Landside R	BK074
94607	Landside L	BK074
94622	Share knife R	BK084
94623	Share knife L	BK084

## Parts to mount on landsides

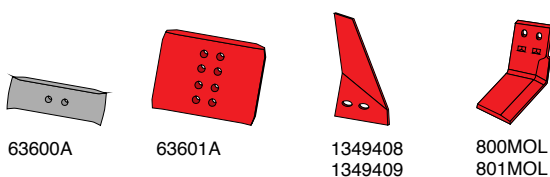

Article no.	Designation	BK. no.
63600A	Wearing plate, rev. R&L	BK094
63601A	Wearing plate, rev. R&L	BK094
1349408	Sword coulter R	BK052
1349409	Sword coulter L	BK052
800MOL	Subsoiler blade R	BK096
801MOL	Subsoiler blade L	BK096

Parts to fit:

# AGROLUX FC ploughbody

## Mouldboards, shins and accessories

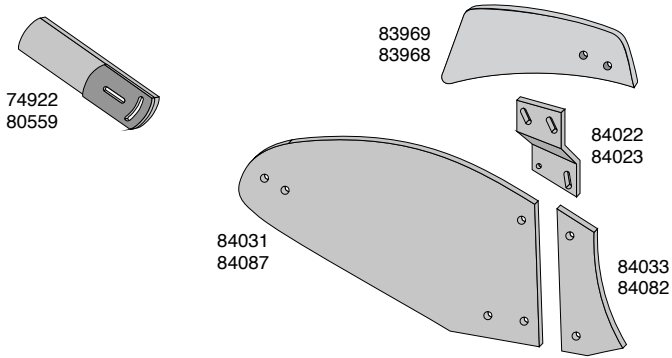

Article no.	Designation	BK. no.
83969	Turbo-trashboard R	BK167
83968	Turbo-trashboard L	BK167
84022	Fittings for trashboard R	
84023	Fittings for trashboard L	
74922	Mouldboard extension R	BK082
80559	Mouldboard extension L	BK082
84031	Mouldboard R	BK062
84087	Mouldboard L	BK062
84033	Shin R	BK065
84082	Shin L	BK065

## Share and points

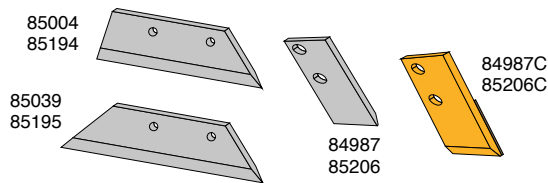

Article no.	Designation	BK. no.
85004	Share 16" R	BK052
85194	Share 16" L	BK052
85039	Share 18" R	BK052
85195	Share 18" L	BK052
84987C	EUROCARBIDE M5 point R	BK031
85206C	EUROCARBIDE M5 point V	BK031
84987	Europoint R	BK031
85206	Europoint L	BK031

## Landsides and share knives

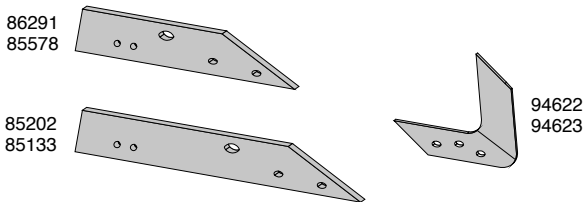

Article no.	Designation	BK. no.
94622	Share knife R	BK084
94623	Share knife L	BK084
86291	Landside, short R	BK073
85578	Landside, short L	BK073
85202	Landside, long R	BK073
85133	Landside, long L	BK073

## Parts to mount on landsides

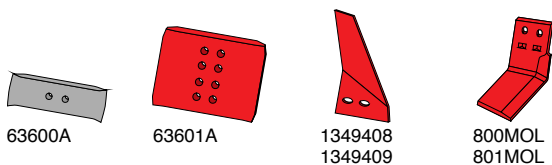

Article no.	Designation	BK. no.
63600A	Wearing plate, rev. R&L	BK094
63601A	Wearing plate, rev. R&L	BK094
1349408	Sword coulter R	BK052
1349409	Sword coulter L	BK052
800MOL	Subsoiler blade R	BK096
801MOL	Subsoiler blade L	BK096

Parts to fit:

# AGROLUX FK ploughbody

## Mouldboards, shins and accessories

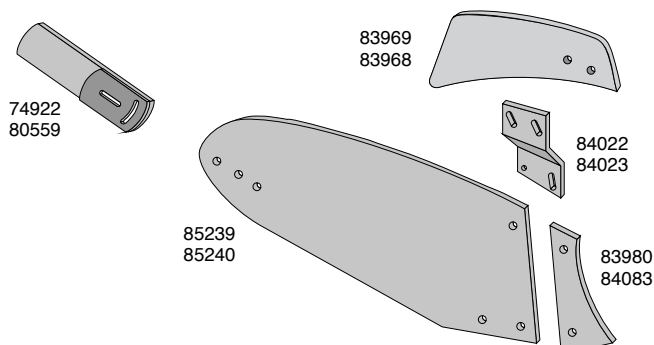

Article no.	Designation	BK. no.
83969	Turbo-trashboard R	BK167
83968	Turbo-trashboard L	BK167
84022	Fittings for trashboard R	
84023	Fittings for trashboard L	
85239	Mouldboard R	BK063
85240	Mouldboard L	BK063
74922	Mouldboard extension R	BK082
80559	Mouldboard extension L	BK082
83980	Shin R	BK065
84083	Shin L	BK065

## Share and points

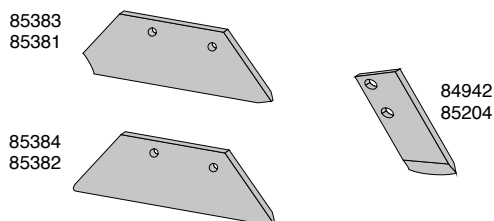

Article no.	Designation	BK. no.
85383	Share 16" R	BK052
85381	Share 16" L	BK052
85384	Share 18" R	BK052
85382	Share 18" L	BK052
84942	Europoint R	BK031
85204	Europoint L	BK031

## Landsides and share knives

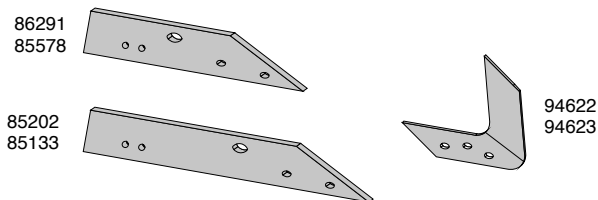

Article no.	Designation	BK. no.
94622	Share knife R	BK084
94623	Share knife L	BK084
85675	Landside, short R	BK073
86126	Landside, short L	BK073
85799	Landside, long R	BK073
86136	Landside, long L	BK073

## Parts to mount on landsides

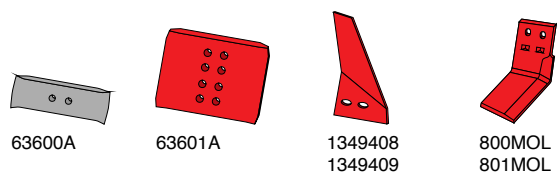

Article no.	Designation	BK. no.
63600A	Wearing plate, rev. R&L	BK094
63601A	Wearing plate, rev. R&L	BK094
1349408	Sword coulter R	BK052
1349409	Sword coulter L	BK052
800MOL	Subsoiler blade R	BK096
801MOL	Subsoiler blade L	BK096

Parts to fit:

## AGROLUX KHN ploughbody

### Share and points

950024-89  
950041-20

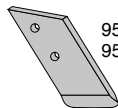
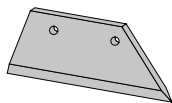

950024-90  
950041-18

Article no.	Designation	BK. no.
950024-89	Share 16" R	BK119
950041-20	Share 16" L	BK119
950024-90	EUROPOINT R	BK119
950041-18	EUROPOINT L	BK119

Parts to fit:

## AGROLUX KH ploughbody

### Share and points

950006-84

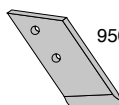
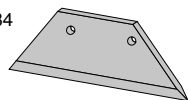

950006-75

Article no.	Designation	BK. no.
950006-84	Share 16" R	BK119
950006-75	Point R	BK119

Parts to fit:

## AGROLUX L, P og PP ploughbody

### Parts to mount on landsides

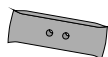

63600A

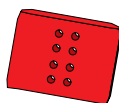

63601A



1349408

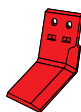

800MOL

Article no.	Designation	BK. no.
63600A	Wearing plate, rev. R&L	BK094
63601A	Wearing plate, rev. R&L	BK094
1349408	Sword coulter R	BK052
800MOL	Subsoiler blade R	BK096



Parts to fit:

# AGROLUX UX plough

## Skim shares and skim mouldboards

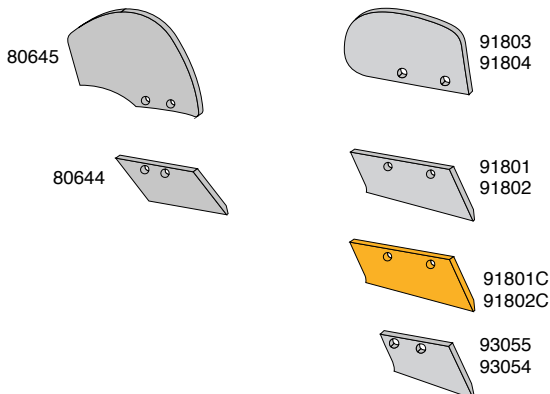

Article no.	Designation	BK. no.
80645	Skim mouldboard R	BK003
91803	Skim mouldboard R	BK052
91804	Skim mouldboard L	BK052
80644	Skim share R	BK050
91801	Skim share R	BK052
91802	Skim share L	BK052
91801C	EUROCARBID Skim share R	BK052
91802C	EUROCARBID Skim share L	BK052
93055	Skim share R	BK052
93054	Skim share L	BK052

## Disc coulters and accessories

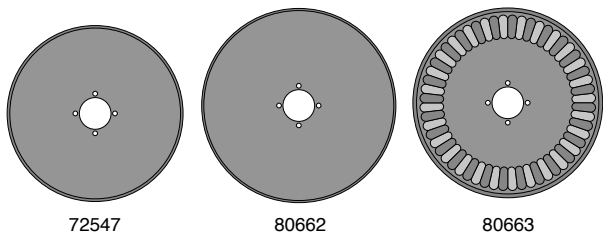

Article no.	Designation
72547	Disc coulter 18" R&L
80662	Disc coulter 20" R&L
80663	Disc coulter, rippled 20" R&L

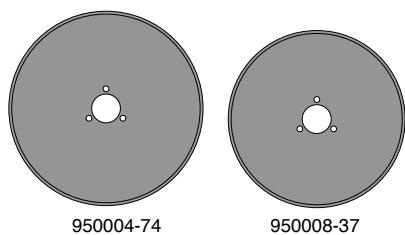

950004-74	Disc coulter 20" R&L
950008-37	Disc coulter 18" R&L

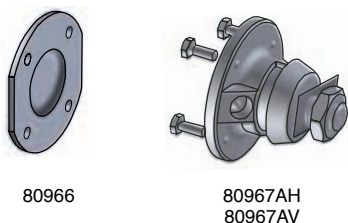

80967AH	Hub for disc coulter M30 R
80967AV	Hub for disc coulter M30 L
80966	Cover for disc coulter R&L

Parts to fit:

# DURO

## Share and points

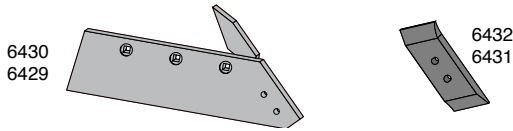

Article no.	Designation	BK. no.
6430	EUROSHARE 16" R	BK171
6429	EUROSHARE 16" L	BK171
6432	Rev. Point R	BK094
6431	Rev. Point L	BK094

## DOWDESWELL DD ploughbody

### Shin

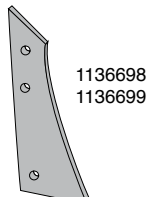

Article no.	Designation	BK. no.
1136698	Shin R	BK058
1136699	Shin L	BK099

### Shares and points

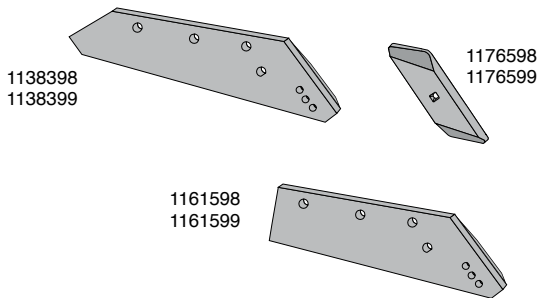

Article no.	Designation	BK. no.
1138398	EUROSHARE 18" R	BK092
1138399	EUROSHARE 18" L	BK092
1176598	EUROPOINT rev. R	BK089
1176599	EUROPOINT rev. L	BK089
1161598	EUROSHARE 16" R	BK092
1161599	EUROSHARE 16" L	BK092

### Landsides

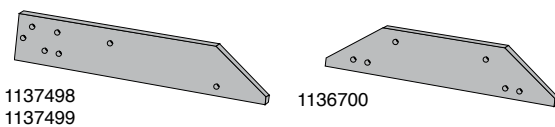

Article no.	Designation	BK. no.
1137498	Landside, long R	BK091
1137499	Landside, long L	BK091
1136700	Landside rev. R&L	BK090

### Parts to mount on landsides

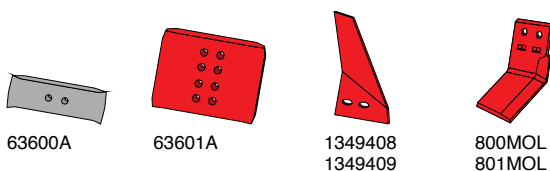

Article no.	Designation	BK. no.
63600A	Wearing plate, rev. R&L	BK094
63601A	Wearing plate, rev. R&L	BK094
1349408	Sword couler R	BK052
1349409	Sword couler L	BK052
800MOL	Subsoiler blade R	BK096
801MOL	Subsoiler blade L	BK096

Parts to fit:

# DOWDESWELL RCN, SCN, UCN ploughbody

## Mouldboards, shins and accessories

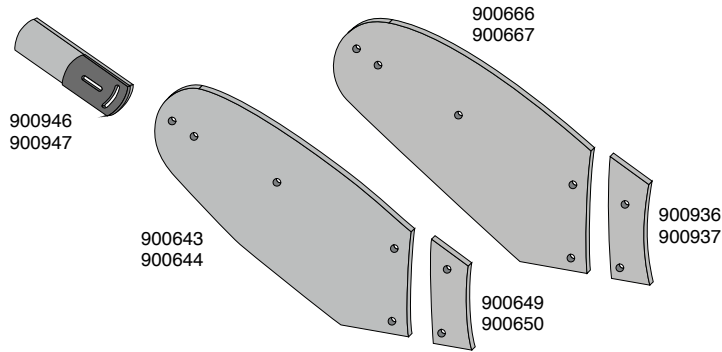

Article no.	Designation	BK. no.
900946	Mouldboard extension R	BK075
900947	Mouldboard extensionL	BK075
900666	Mouldboard R, SCN	BK076
900667	Mouldboard L, SCN	BK076
900643	Mouldboard R, UCN	BK076
900644	Mouldboard L, UCN	BK076
900936	Shin R, SCN	BK069
900937	Shin L, SCN	BK069
900649	Shin R, UCN	BK069
900650	Shin L, UCN	BK069

## Share and points

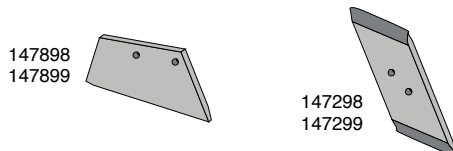

Article no.	Designation	BK. no.
147898	Share R	BK090
147899	Share L	BK090
147298	Rev. point R	BK131
147299	Rev. point L	BK131

## Landsides

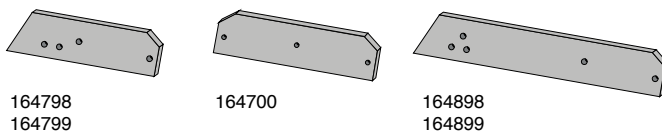

Article no.	Designation	BK. no.
164798	Landside, short R	BK090
164799	Landside, short L	BK090
164700	Landside, rev.R&L	BK090
164898	Landside, long R	BK091
164899	Landside, long L	BK091

## Skim shares and skim mouldboards

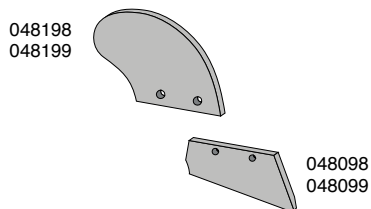

Article no.	Designation	BK. no.
048198	Skim mouldboard R	BK142
048199	Skim mouldboard L	BK142
048098	Skim share R	BK027
048099	Skim share L	BK027

## Parts to mount on landsides

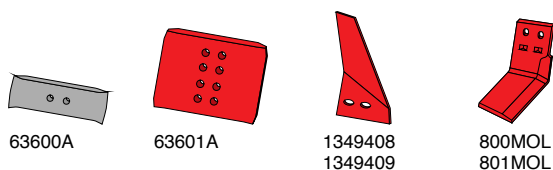

Article no.	Designation	BK. no.
63600A	Wearing plate, rev. R&L	BK094
63601A	Wearing plate, rev. R&L	BK094
1349408	Sword coulter R	BK052
1349409	Sword coulter L	BK052
800MOL	Subsoiler blade R	BK096
801MOL	Subsoiler bladeL	BK096

Parts to fit:

# FORTSCHRITT 30Z and 30ZS ploughbody

## Mouldboards, shins and accessories

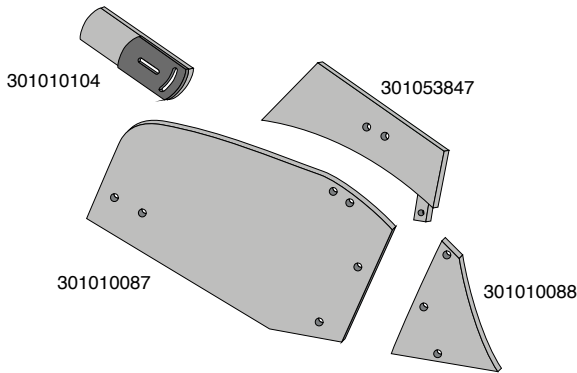

Article no.	Designation	BK. no.
301053847	Turbo-trashboard R	BK016
301010104	Mouldboard extension R	BK015
301010088	Shin R	BK010
301010087	Mouldboard R	BK011

## Share and points

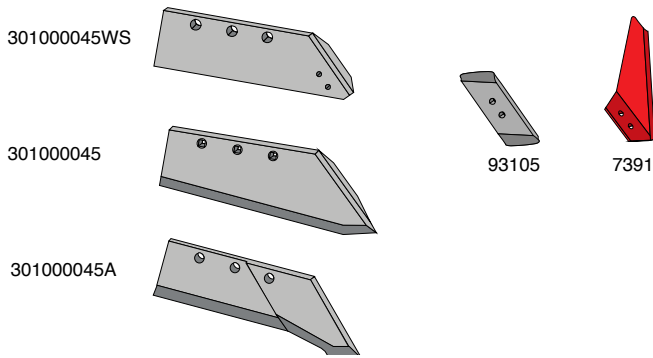

Article no.	Designation	BK. no.
301000045WS	EUROSHARE R	BK037
301000045	EUROSHARE R	BK037
301000045A	Ploughshare R	BK037
93105	Rev. Point R	BK094
73091	Share knife R	BK095

## Landsides

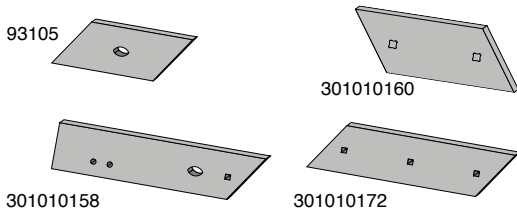

Article no.	Designation	BK. no.
301010171	Landside, short R	BK134
301010158	Landside, long R	BK133
301010172	Landside, long R	BK036
301010160	Landside R	BK036

## Skim shares and skim mouldboards

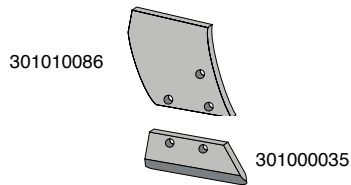

Article no.	Designation	BK. no.
301010086	Skim mouldboard R	BK010
301000035	Skim share R	BK009

## Parts to mount on landsides

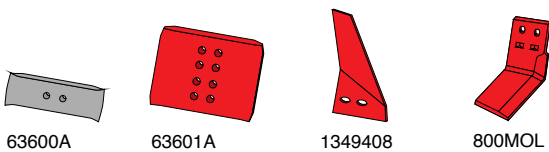

Article no.	Designation	BK. no.
63600A	Wearing plate, rev. R&L	BK094
63601A	Wearing plate, rev. R&L	BK094
1349408	Sword couler R	BK052
800MOL	Subsoiler blade R	BK096



Parts to fit:

## FRAUGDE CAX ploughbody

### Shares, points and accessories

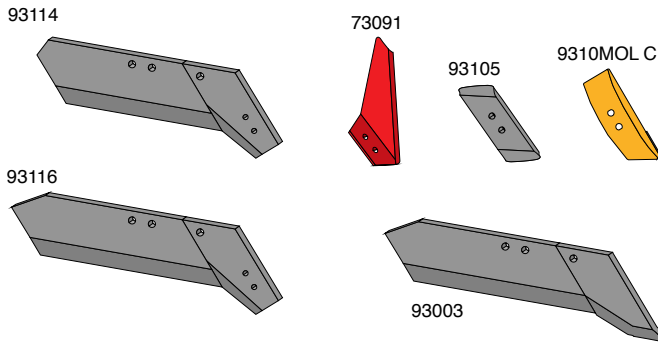

Article no.	Designation	BK. no.
73091	Share knife R	BK095
93105	EUROPOINT Rev. R	BK094
9310MOLC	EUROCARBIDE M3 point R	BK095
93114	Share f/rev. point 14" R	BK123
93116	Share f/rev. point 16" R	BK123
93003	Ploughshare 16" R	BK123

Parts to fit:

## FRAUGDE FK ploughbody

### Shares, points and accessories

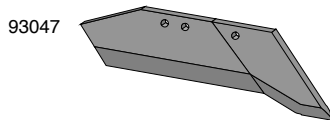

Article no.	Designation	BK. no.
93047	Ploughshare 14" R	BK123

### Landside

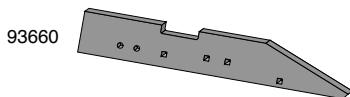

Article no.	Designation	BK. no.
93660	Landside R	BK125

### Parts to mount on landsides

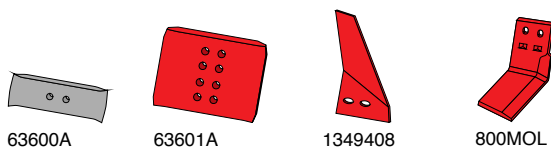

Article no.	Designation	BK. no.
63600A	Wearing plate, rev. R&L	BK094
63601A	Wearing plate, rev. R&L	BK094
1349408	Sword coulter R	BK052
800MOL	Subsoiler blade R	BK096

Parts to fit:

# FRAUGDE FA ploughbody

## Shares, points and accessories

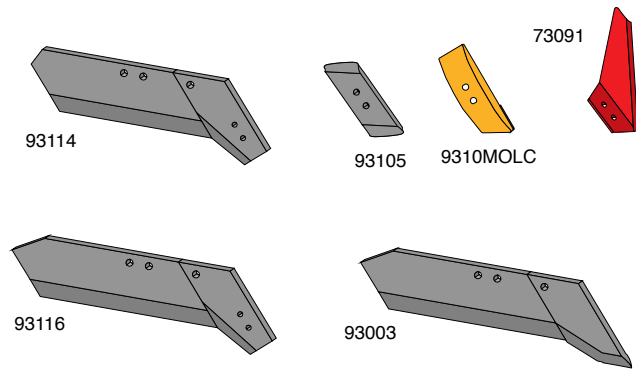

Article no.	Designation	BK. no.
73091	Share knife R	BK095
93105	EUROPOINT Rev. R	BK094
9310MOLC	EUROCARBIDE M3 point R	BK095
93114	Share f/rev. point 14" R	BK123
93116	Share f/rev. point 16" R	BK123
93003	Ploughshare 16" R	BK123

## Landsides

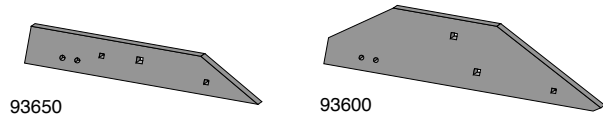

Article no.	Designation	BK. no.
93650	Landside, low R	BK125
93600	Landside, tall R	BK125

## Parts to mount on landsides

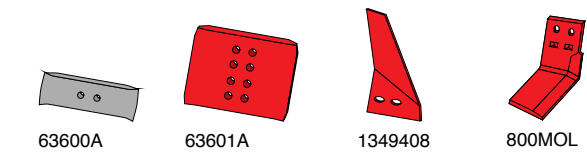

Article no.	Designation	BK. no.
63600A	Wearing plate, rev. R&L	BK094
63601A	Wearing plate, rev. R&L	BK094
1349408	Sword coulter R	BK052
800MOL	Subsoiler blade R	BK096

**Do you know...**  
 that our sword coulter 1349408/1349409  
 will reduce the risk of damages from  
 stones by more than 90% if you are  
 using wide tires.

Parts to fit:

# FRAUGDE FA and FKA ploughbody

## Shin

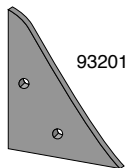

Article no.	Designation	BK. no.
93201	Shin R	BK119

## Shares, points and accessories

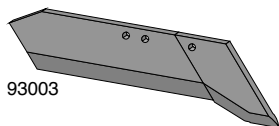
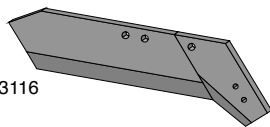
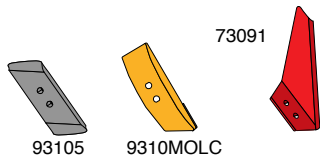
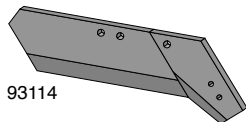

Article no.	Designation	BK. no.
73091	Share knife R	BK095
93105	EUROPOINT Rev. R	BK094
9310MOLC	EUROCARBIDE M3 point R	BK095
93114	Share f/rev. point 14" R	BK123
93116	Share f/rev. point 16" R	BK123
93003	Ploughshare 16" R	BK123

## Landsides

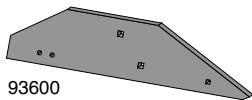
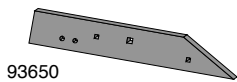

Article no.	Designation	BK. no.
93650	Landside, low R	BK125
93600	Landside, tall R	BK125

## Parts to mount on landsides

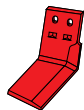
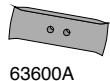

Article no.	Designation	BK. no.
63600A	Wearing plate, rev. R&L	BK094
63601A	Wearing plate, rev. R&L	BK094
1349408	Sword coulter R	BK052
800MOL	Subsoiler blade R	BK096

Parts to fit:

# FRAUGDE FS and GS ploughbody

## Accessories

73/63-300

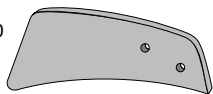

73/63-310



Article no.	Designation	BK. no.
73/63-300	Turbo -trashboard R	BK167
73/63-310	Fittings for trashboard R	

## Shares, points and accessories

53087

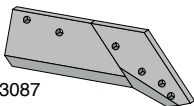

53090



5309MOL C

73091



Article no.	Designation	BK. no.
73091	Share knife R	BK095
53090	EUROPOINT Rev. R	BK094
5309MOLC	EUROCARBIDE M3 point R	BK095

53087	Share f/rev. 14" R	BK100
53088	Share f/rev. 16" R	BK100

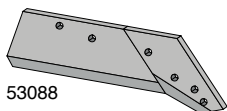

53088

## Landside

53684

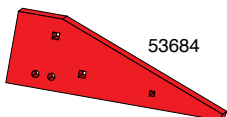

Article no.	Designation	BK. no.
53684	Landside, short R	BK118

## Parts to mount on landsides

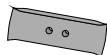

63600A

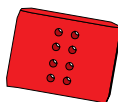

63601A



1349408



800MOL

Article no.	Designation	BK. no.
63600A	Wearing plate, rev. R&L	BK094
63601A	Wearing plate, rev. R&L	BK094
1349408	Sword coulter R	BK052
800MOL	Subsoiler blade R	BK096

**Do you know...**  
 When Mølbro's share and point is mounted on the plough body it is always the point entering the soil first.



Parts to fit:

# FRAUGDE MS ploughbody

## Mouldboards, shins and accessories

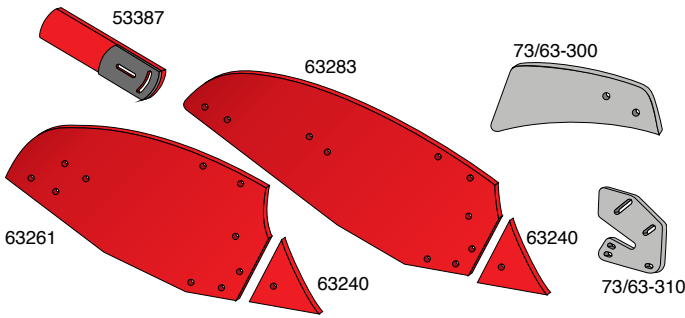

Article no.	Designation	BK. no.
73/63-300	Turbo-trashboard R	BK167
73/63-310	Fittings for trashboard R	
63283	Mouldboard R	BK056
63261	Mouldboard R	BK056
53387	Mouldboard extension R	
63240	Shin R	BK082 BK053

## Shares, points and accessories

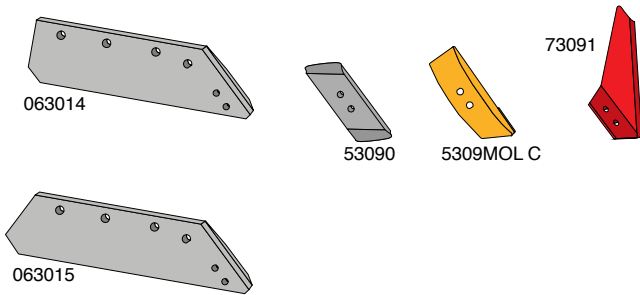

Article no.	Designation	BK. no.
063014	EUROSHARE 14" R	BK100
063015	EUROSHARE 16" R	BK100
73091	Share knife R	BK095
53090	EUROPOINT Rev. R	BK094
5309MOLC	EUROCARBIDE M3 point R	BK095

## Landsides

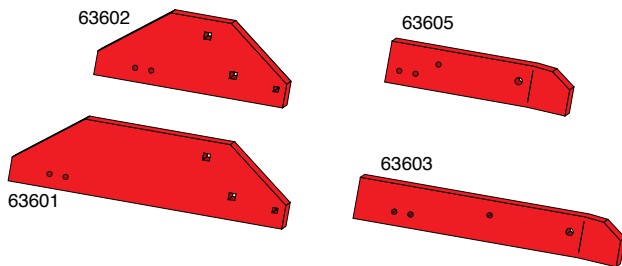

Article no.	Designation	BK. no.
63602	Landside, short R	BK118
63601	Landside, long R	BK118
63605	Landside, short, low R	BK103
63603	Landside, long, low R	BK103

## Parts to mount on landsides

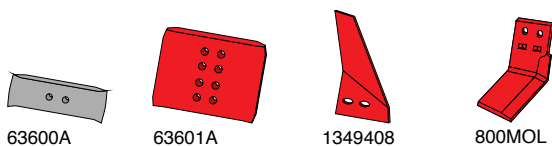

Article no.	Designation	BK. no.
63600A	Wearing plate, rev. R&L	BK094
63601A	Wearing plate, rev. R&L	BK094
1349408	Sword coulter R	BK052
800MOL	Subsoiler blade R	BK096

Parts to fit:

# FRAUGDE 208 ploughbody

## Mouldboards, shins and accessories

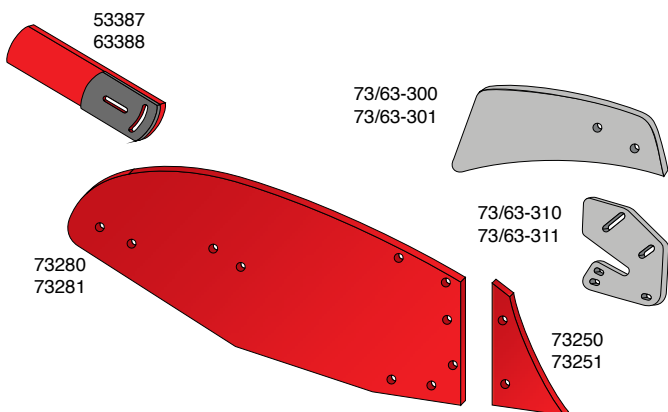

Article no.	Designation	BK. no.
73/63-300	Turbo-trashboard R	BK167
73/63-301	Turbo-trashboard L	BK167
73/63-310	Fittings for trashboard R	
73/63-311	Fittings for trashboard L	
53387	Mouldboard extension R	BK082
63388	Mouldboard extension L	BK082
73280	Mouldboard R	BK056
73281	Mouldboard L	BK056
73250	Shin R	BK052
73251	Shin L	BK052

## Share and points

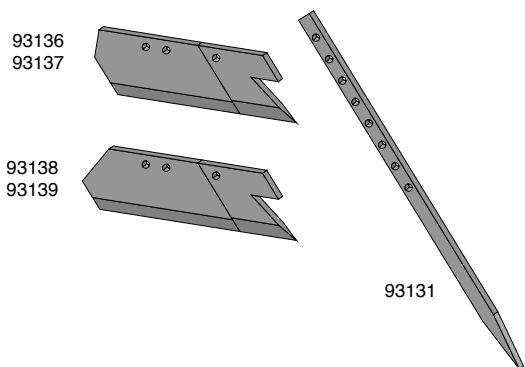

Article no.	Designation	BK. no.
93131	Barpoint R&L	
93136	Share for barpoint 14" R	BK099
93137	Share for barpoint 14" L	BK099
93138	Share for barpoint 16" R	BK099
93139	Share for barpoint 16" L	BK099

## Landside

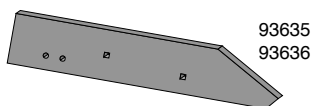

Article no.	Designation	BK. no.
93635	Landside R	BK050
93636	Landside L	BK050

## Parts to mount on landsides

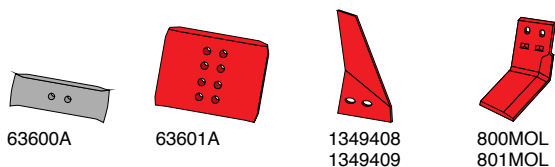

Article no.	Designation	BK. no.
63600A	Wearing plate, rev. R&L	BK094
63601A	Wearing plate, rev. R&L	BK094
1349408	Sword coulter R	BK052
1349409	Sword coulter L	BK052
800MOL	Subsoiler blade R	BK096
801MOL	Subsoiler blade L	BK096

Parts to fit:

# FRAUGDE

## Skim shares and skim mouldboards

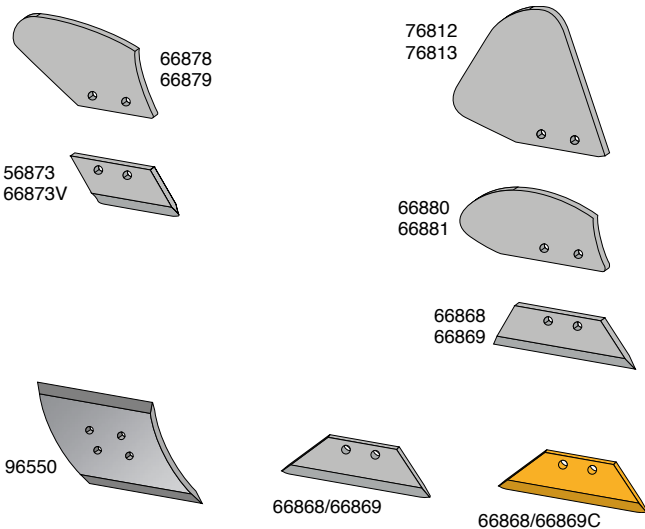

Article no.	Designation	BK. no.
66878	Skim mouldboard R	BK026
66879	Skim mouldboard L	Bk026
56873	Skim share, short R	BK004
66873V	Skim share, short L	BK004
76812	Skim mouldboard R	BK026
76813	Skim mouldboard L	BK026
66880	Skim mouldboard R	BK026
66881	Skim mouldboard L	BK026
66868	Skim share, long R	BK004
66869	Skim share, long L	BK004
66868/66869	Skim share, R&L	BK004
66868/66869C	EUROCARBID Skim share, R&L	BK004
96550	Skim share, rev. R	BK002

## Disc coulters and accessories

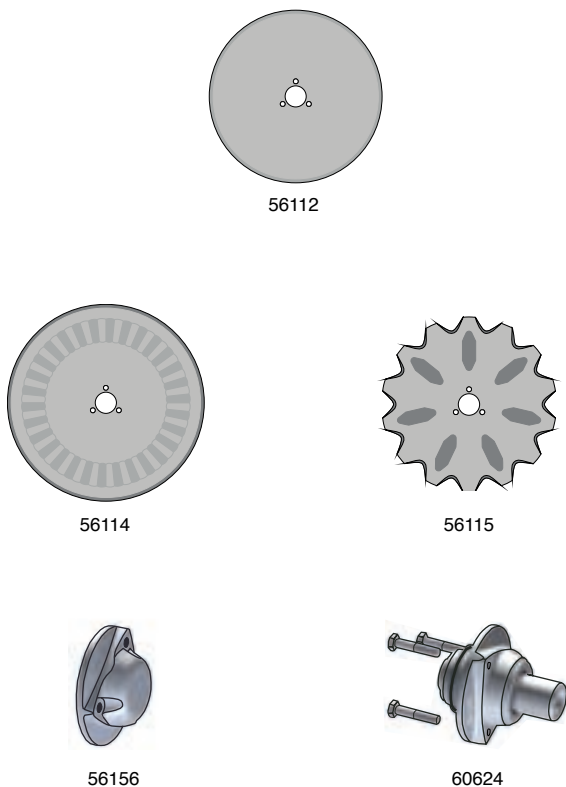

Article no.	Designation
56112	Disc coulters 18" R&L
56114	Disc coulters, rippled 20" R&L
56115	Disc coulters, notched 18" R&L
56156	Universal cover for hub R&L
60624	Hub for disc coulters Ø30 mm R&L

Parts to fit:

# GOIZIN

## Share and points

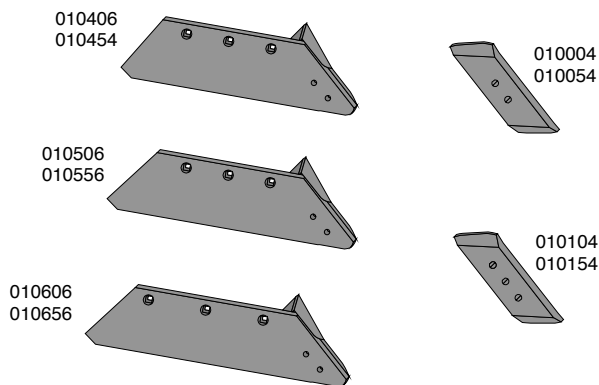

Article no.	Designation
010406	EUROSHARE 14" R
010456	EUROSHARE 14" L
010506	EUROSHARE 15" R
010556	EUROSHARE 15" L
010606	EUROSHARE 16" R
010656	EUROSHARE 16" L
010004	EUROPOINT Rev. R
010054	EUROPOINT Rev. L
010104	EUROPOINT Rev. R
010154	EUROPOINT Rev. L

## Skim shares



Article no.	Designation
010732D	Skim share R
010782G	Skim share L

## Landsides

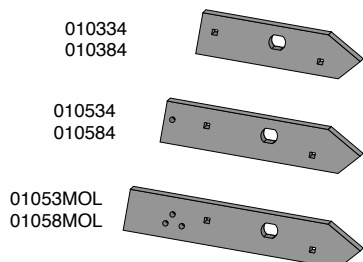

Article no.	Designation
010334	Landside R
010384	Landside L
010534	Landside R
010584	Landside L
01053MOL	Landside R
01058MOL	Landside L

## Parts to mount on landsides

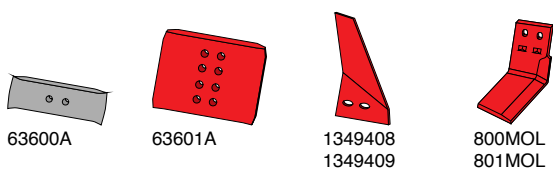

Article no.	Designation	BK. no.
63600A	Wearing plate, rev. R&L	BK094
63601A	Wearing plate, rev. R&L	BK094
1349408	Sword coulter R	BK052
1349409	Sword coulter L	BK052
800MOL	Subsoiler blade R	BK096
801MOL	Subsoiler blade L	BK096

Parts to fit:

# GREGOIRE-BESSON

## Mouldboards, shins and accessories

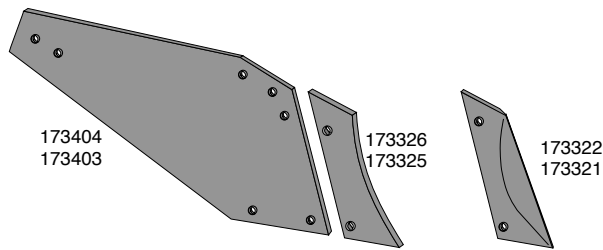

Article no.	Designation	BK. no.
173404	Mouldboard R	
173403	Mouldboard L	
173326	Shin R	BK052
173325	Shin L	BK052
173322	Shin R	BK052
173321	Shin L	BK052

## Share and points

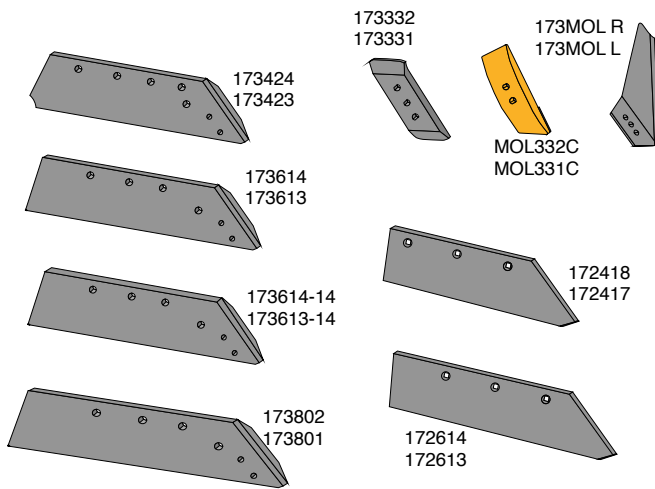

Article no.	Designation	BK. no.
173424	EUROSHARE 14" R	BK114
173423	EUROSHARE 14" L	BK114
173614	EUROSHARE 16" R	BK113
173613	EUROSHARE 16" L	BK113
173614-14	EUROSHARE 16" R 14mm	
173613-14	EUROSHARE 16" L 14mm	
173802	EUROSHARE 18" R	BK113
173801	EUROSHARE 18" L	BK113
173332	EUROPOINT Rev. R	BK095
173331	EUROPOINT Rev. L	BK095
173MOL R	Share knife R (173324)	BK096
173MOL L	Share knife L (173324)	BK096
MOL332C	EUROCARBIDE M3 point R	BK095
MOL331C	EUROCARBIDE M3 point L	BK095
172418	Share 14" R	
172417	Share 14" L	
172614	Share 16" R	
172613	Share 16" L	

## Skim shares and skim mouldboards

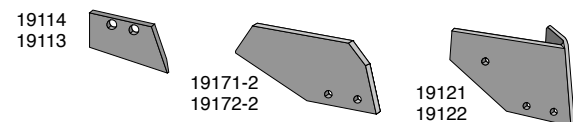

Article no.	Designation	BK. no.
19114	Skim shares R	BK052
19113	Skim shares L	BK052
19172-2	Skim mouldboard R	BK052
19171-2	Skim mouldboard L	BK052
19122	Skim mouldboard R	
19121	Skim mouldboard L	

## Landsides

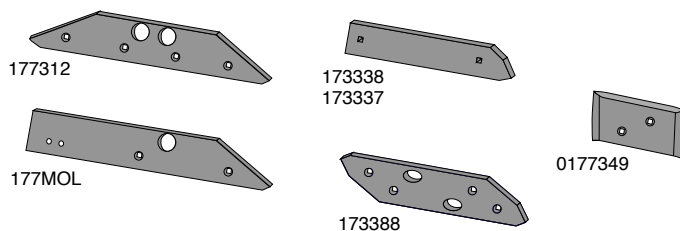

Article no.	Designation	BK. no.
177312	Landside R&L	BK036
177MOL	Landside R&L	BK036
173338	Landside, short R	BK036
173337	Landside, short L	BK036
173388	Landside, rev. R&L	BK036
0177349	Wearing plate, rev. R&L	BK036

## Parts to mount on landsides

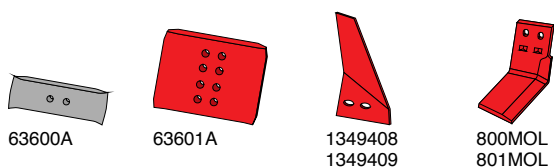

Article no.	Designation	BK. no.
63600A	Wearing plate, rev. R&L	BK094
63601A	Wearing plate, rev. R&L	BK094
1349408	Sword coulter R	BK052
1349409	Sword coulter L	BK052
800MOL	Subsoiler blade R	BK096
801MOL	Subsoiler blade L	BK096

Parts to fit:

# KUHN RH/RLM ploughbody

## Mouldboards

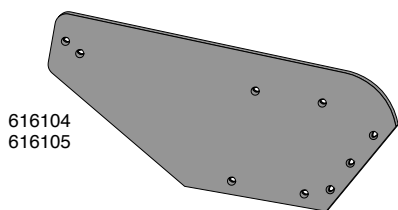

Article no.	Designation
616104	Mouldboard R
616105	Mouldboard L

## Shares, points and accessories

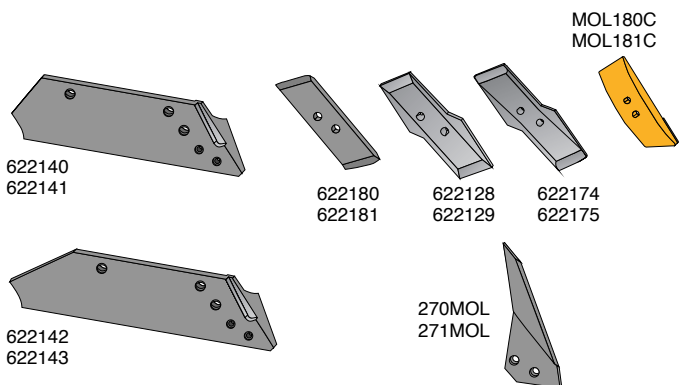

Article no.	Designation	BK. no.
622180	EUROPOINT rev. R	BK095
622181	EUROPOINT rev. L	BK095
MOL180C	EUROCARBIDE M3 point R	BK095
MOL181C	EUROCARBIDE M3 point L	BK095
622128	EUROPOINT Z R	BK095
622129	EUROPOINT Z L	BK095
622174	EUROPOINT Z reinforc. R	BK095
622175	EUROPOINT Z reinforc. L	BK095
622140	Share f/rev. point 14" R	BK112
622141	Share f/rev. point 14" L	BK112
622142	Share f/rev. point 16" R	BK112
622143	Share f/rev. point 16" L	BK112
270MOL	Share knife R	
271MOL	Share knife L	

## Landsides and accessories

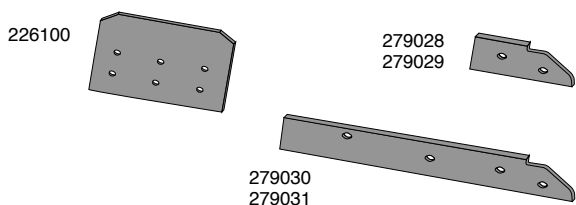

Article no.	Designation	BK. no.
279028	Landside, short R	BK069
279029	Landside, short L	BK069
279030	Landside, long R	BK057
279031	Landside, long L	BK057
226100	Steering plate R&L	

Parts to fit:

# KUHN PP and C ploughbody

## Landsides and accessories

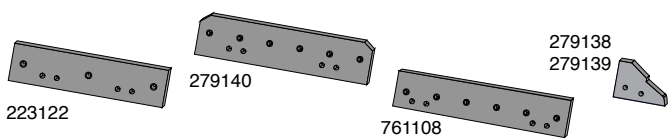

Article no.	Designation	BK. no.
223122	Landside, rev. R&L	BK099
279140	Landside, rev. R&L	BK099
761108	Landside, rev. R&L	BK099
279138	Skim point R	BK098
279139	Skim point L	BK098

## Parts to mount on landsides

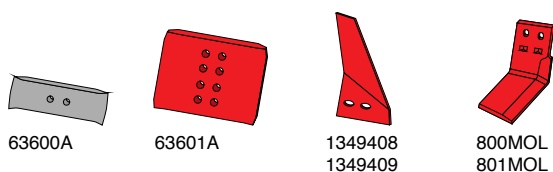

Article no.	Designation	BK. no.
63600A	Wearing plate, rev. R&L	BK094
63601A	Wearing plate, rev. R&L	BK094
1349408	Sword coulter R	BK052
1349409	Sword coulter L	BK052
800MOL	Subsoiler blade R	BK096
801MOL	Subsoiler blade L	BK096



Parts to fit:

# KUHN H4 and H6 ploughbody

## Mouldboards, shins and accessories

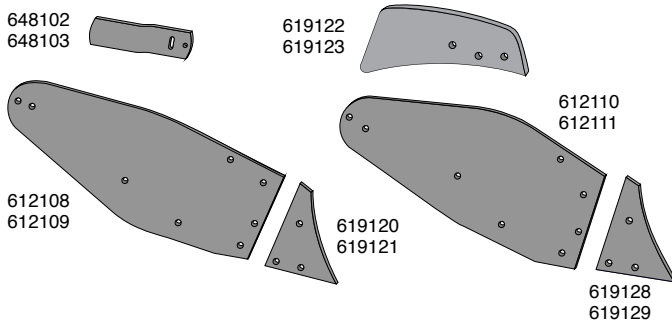

Article no.	Designation	BK. no.
619122	Turbo-trashboard R	BK069
619123	Turbo-trashboard L	BK069
612108	Mouldboard R H4	BK071
612109	Mouldboard L H4	BK071
619120	Shin R H4	BK077
619121	Shin L H4	BK077
612110	Mouldboard R H6	BK071
612111	Mouldboard L H6	BK071
619128	Shin R H6	BK077
619129	Shin L H6	BK077
648102	Mouldboard extension R	BK084
648103	Mouldboard extension L	BK084

## Share and points

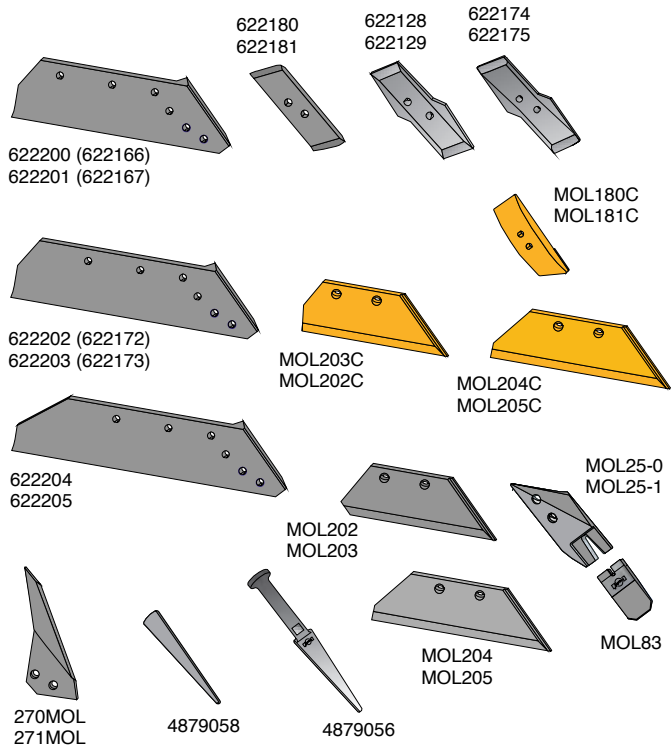

Article no.	Designation	BK. no.
622200	EUROSHARE 14" R	BK113
622201	EUROSHARE 14" L	BK113
622202	EUROSHARE 16" R	BK113
622203	EUROSHARE 16" L	BK113
622204	EUROSHARE 18" R	BK113
622205	EUROSHARE 18" L	BK113
622128	EUROPOINT Z R	BK095
622129	EUROPOINT Z L	BK095
622174	EUROPOINT Z reinforc. R	BK095
622175	EUROPOINT Z reinforc. L	BK095
622180	EUROPOINT rev. R	BK095
622181	EUROPOINT rev. L	BK095
MOL180C	EUROCARBIDE M3 point R	BK095
MOL181C	EUROCARBIDE M3 point L	BK095
MOL202C	EUROCARBIDE M5 share 16" R	BK165
MOL203C	EUROCARBIDE M5 share 16" L	BK165
MOL204C	EUROCARBIDE M5 share 18" R	BK165
MOL205C	EUROCARBIDE M5 share 18" L	BK165
MOL202	SHARE M5 16" R	BK165
MOL203	SHARE M5 16" L	BK165
MOL204	SHARE M5 18" R	BK165
MOL205	SHARE M5 18" L	BK165
MOL25-0	M7 adapter R	BK166
MOL25-1	M7 adapter L	BK166
MOL83	M7 point rev. R&L	BK166
4879058	Wedge for M7 point	BK166
4879056	Wedge for M7 point	BK166
270MOL	Share knife R	BK166
271MOL	Share knife L	BK166

For KUHN EUROSHARE, use KUHN landside point  
223120/223121 - 223120MOL/223121MOL

## Landsides

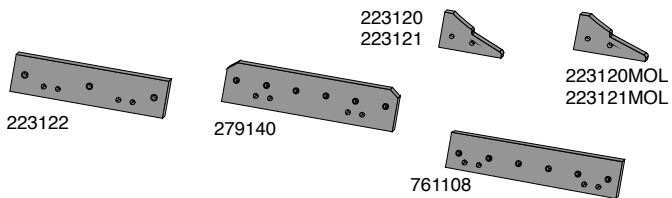

Article no.	Designation	BK. no.
223120	Skim point R	BK097
223121	Skim point L	BK097
223120MOL	Skim point R	BK097
223121MOL	Skim point L	BK097
223122	Landside, rev. R&L	BK099
279140	Landside, rev. R&L	BK099
761108	Landside, rev. R&L	BK099

## Parts to mount on landsides

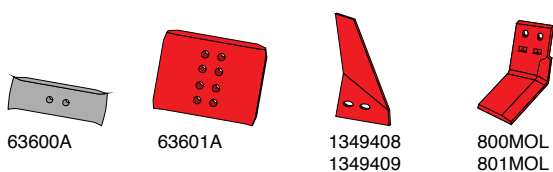

Article no.	Designation	BK. no.
63600A	Wearing plate, rev. R&L	BK097
63601A	Wearing plate, rev. R&L	BK097
1349408	Sword coulter R	BK097
1349409	Sword coulter L	BK097
800MOL	Subsoiler blade R	BK099
801MOL	Subsoiler blade L	BK099

Parts to fit:

# KUHN HB4 and HB6 ploughbody

## Mouldboards, shins and accessories

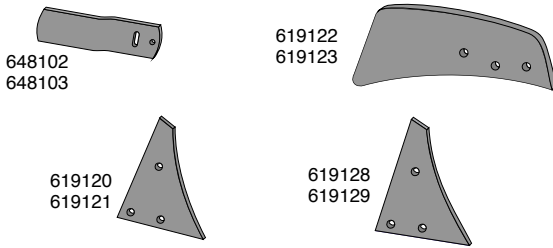

Article no.	Designation	BK. no.
619122	Turbo-trashboard R	BK069
619123	Turbo-trashboard L	BK069
619120	Shin R H4	BK077
619121	Shin L H4	BK077
619128	Shin R H6	BK077
619129	Shin L H6	BK077
648102	Mouldboard extension R	BK084
648103	Mouldboard extension L	BK084

## Share and points

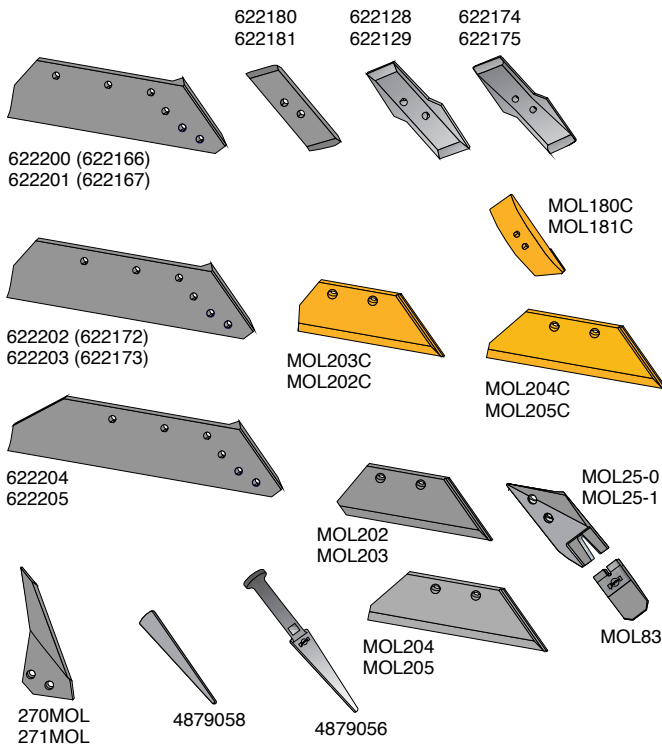

Article no.	Designation	BK. no.
622200	EUROSHARE 14" R	BK113
622201	EUROSHARE 14" L	BK113
622202	EUROSHARE 16" R	BK113
622203	EUROSHARE 16" L	BK113
622204	EUROSHARE 18" R	BK113
622205	EUROSHARE 18" L	BK113
622128	EUROPOINT Z R	BK095
622129	EUROPOINT Z L	BK095
622174	EUROPOINT Z reinforc. R	BK095
622175	EUROPOINT Z reinforc. L	BK095
622180	EUROPOINT rev. R	BK095
622181	EUROPOINT rev. L	BK095
MOL180C	EUROCARBIDE M3 point R	BK095
MOL181C	EUROCARBIDE M3 point L	BK095
MOL202C	EUROCARBIDE M5 share 16" R	BK165
MOL203C	EUROCARBIDE M5 share 16" L	BK165
MOL204C	EUROCARBIDE M5 share 18" R	BK165
MOL205C	EUROCARBIDE M5 share 18" L	BK165
MOL202	SHARE M5 16" R	BK165
MOL203	SHARE M5 16" L	BK165
MOL204	SHARE M5 18" R	BK165
MOL205	SHARE M5 18" L	BK165
MOL25-0	M7 adapter R	BK166
MOL25-1	M7 adapter L	BK166
MOL83	M7 point rev. R&L	BK166
4879058	Wedge for M7 point	BK166
4879056	Wedge for M7 point	BK166
270MOL	Share knife R	BK166
271MOL	Share knife L	BK166

For KUHN EUROSHARE, use KUHN landside point  
223120/223121 - 223120MOL/223121MOL

## Landsides

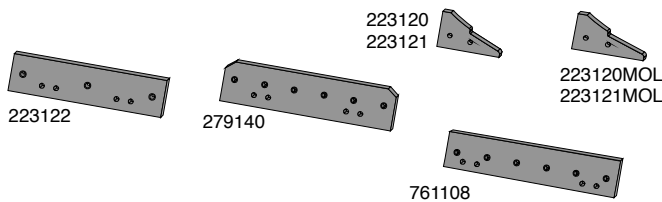

Article no.	Designation	BK. no.
223120	Skim point R	BK097
223121	Skim point L	BK097
223120MOL	Skim point R	BK097
223121MOL	Skim point L	BK097
223122	Landside, rev. R&L	BK099
279140	Landside, rev. R&L	BK099
761108	Landside, rev. R&L	BK099

## Parts to mount on landsides

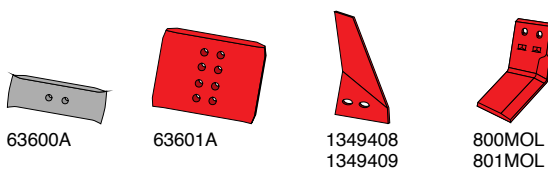

Article no.	Designation	BK. no.
63600A	Wearing plate, rev. R&L	BK094
63601A	Wearing plate, rev. R&L	BK094
1349408	Sword coulters R	BK052
1349409	Sword coulters L	BK052
800MOL	Subsoiler blade R	BK096
801MOL	Subsoiler blade L	BK096

Parts to fit:

# KUHN SK ploughbody

## Mouldboards, shins and accessories

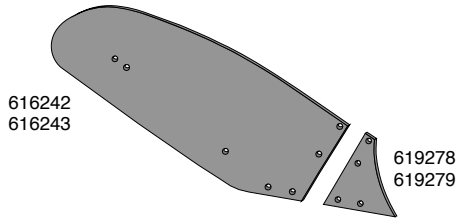

Article no.	Designation	BK. no.
616242	Mouldboard R	BK071
616243	Mouldboard L	BK071
619278	Shin R	BK150
619279	Shin L	BK150

## Share and points

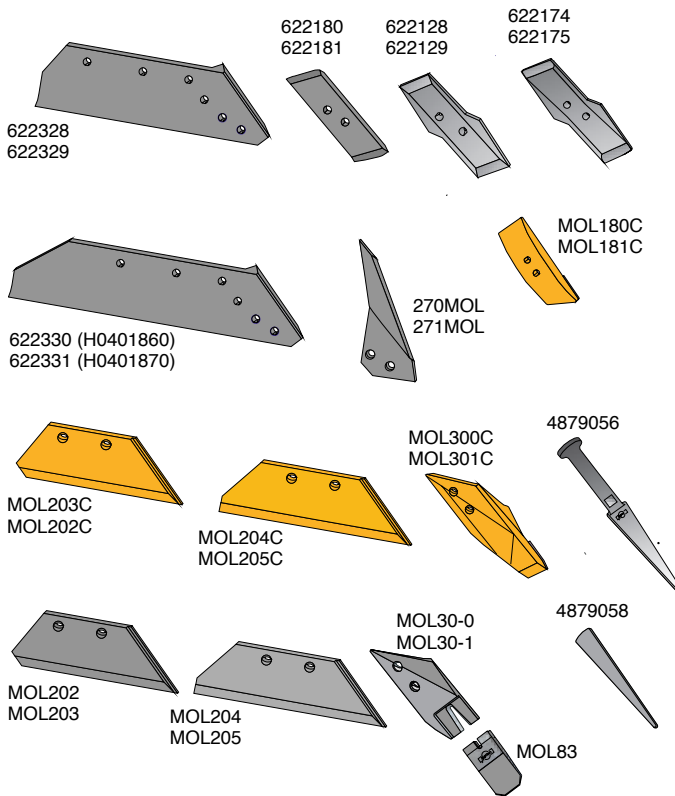

Article no.	Designation	BK. no.
622180	EUROPOINT rev. R	BK095
622181	EUROPOINT rev. L	BK095
MOL180C	EUROCARBIDE M3 point R	BK095
MOL181C	EUROCARBIDE M3 point L	BK095
622128	EUROPOINT Z R	BK095
622129	EUROPOINT Z L	BK095
622174	EUROPOINT Z reforc. R	BK095
622175	EUROPOINT Z reforc. L	BK095
622328	Share f/rev. point 14" R	BK113
622329	Share f/rev. point 14" L	BK113
622330	Share f/rev. point 16" R	BK113
622331	Share f/rev. point 16" L	BK113
MOL202C	EUROCARBIDE M5 share 16" R	BK165
MOL203C	EUROCARBIDE M5 share 16" L	BK165
MOL204C	EUROCARBIDE M5 share 18" R	BK165
MOL205C	EUROCARBIDE M5 share 18" L	BK165
MOL202	SHARE M5 16" R	BK166
MOL203	SHARE M5 16" L	BK166
MOL204	SHARE M5 18" R	BK166
MOL205	SHARE M5 18" L	BK166
MOL30-0	M7 adapter R	BK166
MOL30-1	M7 adapter L	BK166
MOL83	M7 point rev. R&L	
4879058	Wedge for M7 point	
4879056	Wedge for M7 point	
MOL300C	EUROCARBIDE M5 point R	BK166
MOL301C	EUROCARBIDE M5 point L	BK166
270MOL	Share knife R	
271MOL	Share knife L	

For KUHN EUROSHARE, use KUHN landside point  
MOL761216/MOL761217

## Landsides

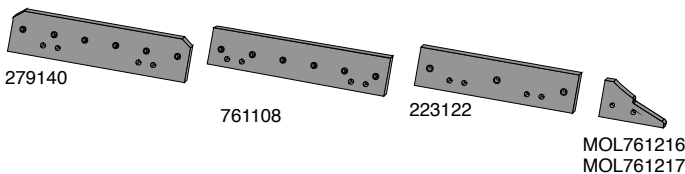

Article no.	Designation	BK. no.
279140	Landside, rev. R&L	BK099
761108	Landside, rev. R&L	BK099
MOL761216	Skim point R	BK097
MOL761217	Skim point L	BK097
223122	Landside, rev. R&L	BK099

## Parts to mount on landsides

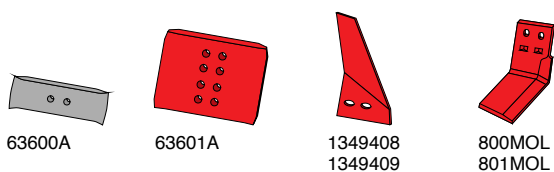

Article no.	Designation	BK. no.
63600A	Wearing plate, rev. R&L	BK094
63601A	Wearing plate, rev. R&L	BK094
1349408	Sword coulter R	BK052
1349409	Sword coulter L	BK052
800MOL	Subsoiler blade R	BK092
801MOL	Subsoiler blade L	BK092

Parts to fit:

# KUHN VL ploughbody

## Shin

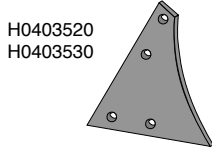

Article no.	Designation	BK. no.
H0403520	Shin R	BK150
H0403530	Shin L	BK150

## Shares, points and accessories

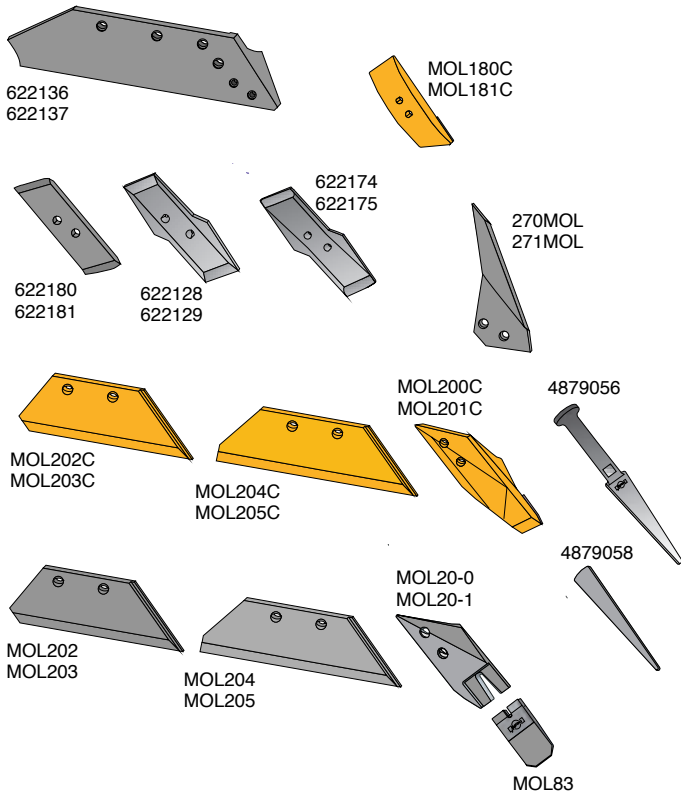

Article no.	Designation	BK. no.
622180	EUROPOINT rev. R	BK095
622181	EUROPOINT rev. L	BK095
MOL180C	EUROCARBIDE M3 point R	BK095
MOL181C	EUROCARBIDE M3 point L	BK095
622128	EUROPOINT Z R	BK095
622129	EUROPOINT Z L	BK095
622174	EUROPOINT Z reforc. R	BK095
622175	EUROPOINT Z reforc. L	BK095
MOL200C	EUROCARBIDE M5 point R	BK166
MOL201C	EUROCARBIDE M5 point L	BK166
622136	EUROSHARE 16" L	BK176
622137	EUROSHARE 16" R	BK176
MOL202C	EUROCARBIDE M5/M7 share 16" R	BK165
MOL203C	EUROCARBIDE M5/M7 share 16" L	BK165
MOL204C	EUROCARBIDE M5/M7 share 18" R	BK165
MOL205C	EUROCARBIDE M5/M7 share 18" L	BK165
MOL202	SHARE M5/M7 16" R	BK165
MOL203	SHARE M5/M7 16" L	BK165
MOL204	SHARE M5/M7 18" R	BK165
MOL205	SHARE M5/M7 18" L	BK165
MOL20-0	M7 adapter R	BK166
MOL20-1	M7 adapter L	BK166
MOL83	M7 point rev. R&L	
4879058	Wedge for M7 point	
4879056	Wedge for M7 point	
270MOL	Share knife R	
271MOL	Share knife L	

## Landsides

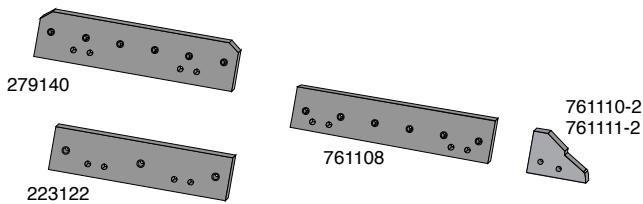

Article no.	Designation	BK. no.
279140	Landside, rev. R&L	BK099
223122	Landside, rev. R&L	BK099
761108	Landside, rev. R&L	BK099
761110-2	Skim point R	BK098
761111-2	Skim point L	BK098

## Parts to mount on landsides

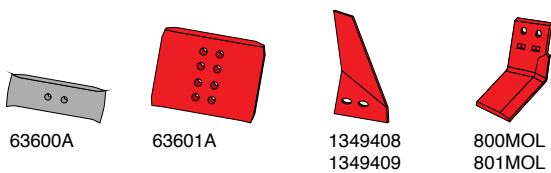

Article no.	Designation	BK. no.
63600A	Wearing plate, rev. R&L	BK094
63601A	Wearing plate, rev. R&L	BK094
1349408	Sword coulter R	BK052
1349409	Sword coulter L	BK052
800MOL	Subsoiler blade R	BK096
801MOL	Subsoiler blade L	BK096

Parts to fit:

# KUHN VS/N ploughbody

## Shin

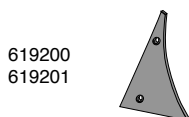

Article no.	Designation	BK. no.
619200	Shin R	BK052
619201	Shin L	BK052

## Shares, points and accessories

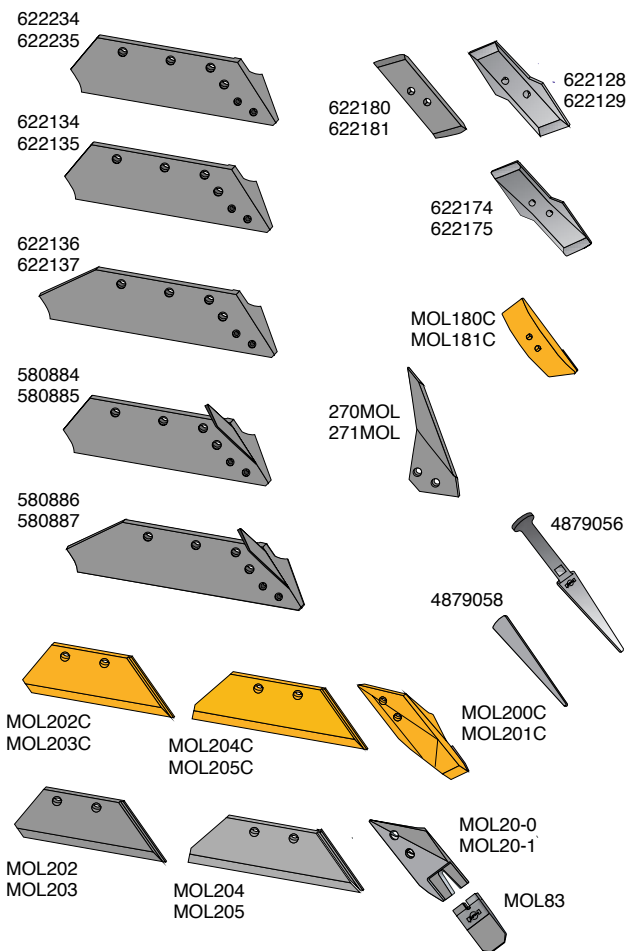

Article no.	Designation	BK. no.
622234	EUROSHARE 16" R	BK176
622235	EUROSHARE 16" L	BK176
622180	EUROPOINT rev. R	BK095
622181	EUROPOINT rev. L	BK095
MOL180C	EUROCARBIDE M3 point R	BK095
MOL181C	EUROCARBIDE M3 point L	BK095
622128	EUROPOINT Z R	BK095
622129	EUROPOINT Z L	BK095
622174	EUROPOINT Z reforc. R	BK095
622175	EUROPOINT Z reforc. L	BK095
MOL200C	EUROCARBIDE M5 point R	BK166
MOL201C	EUROCARBIDE M5 point L	BK166
622134	EUROSHARE 14" R	BK176
622135	EUROSHARE 14" L	BK176
622136	EUROSHARE 16" R	BK176
622137	EUROSHARE 16" L	BK176
580884	EUROSHARE 14" R	BK176
580885	EUROSHARE 14" L	BK176
580886	EUROSHARE 16" R	BK176
580887	EUROSHARE 16" L	BK176
MOL202C	EUROCARBIDE M5/M7 share 16" R	BK165
MOL203C	EUROCARBIDE M5/M7 share 16" L	BK165
MOL204C	EUROCARBIDE M5/M7 share 18" R	BK165
MOL205C	EUROCARBIDE M5/M7 share 18" L	BK165
MOL202	SHARE M5/M7 16" R	BK165
MOL203	SHARE M5/M7 16" L	BK165
MOL204	SHARE M5/M7 18" R	BK165
MOL205	SHARE M5/M7 18" L	BK165
MOL20-0	M7 adapter R	BK166
MOL20-1	M7 adapter L	BK166
MOL83	M7 point rev. R&L	BK166
4879058	Wedge for M7 point	
4879056	Wedge for M7 point	
270MOL	Share knife R	
271MOL	Share knife L	

## Landsides

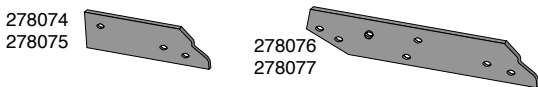

Article no.	Designation	BK. no.
278074	Landside, short R	BK077
278075	Landside, short L	BK077
278076	Landside, long R	BK072
278077	Landside, long L	BK072

Parts to fit:

# KUHN

## Skim shares and skim mouldboards

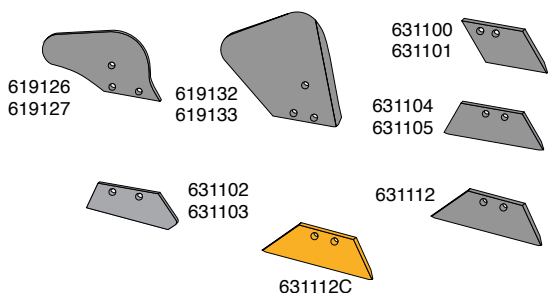

Article no.	Designation	BK. no.
619126	Skim mouldboard R	BK058
619127	Skim mouldboard L	BK058
619132	Skim mouldboard R	BK058
619133	Skim mouldboard L	BK058
631100	Skim share R	BK052
631101	Skim share L	BK052
631102	Skim share R	BK052
631103	Skim share L	BK052
631104	Skim share R	BK052
631105	Skim share L	BK052
631112	Skim share R&L	BK052
631112C	EUROCARBID Skim share R&L	BK052



Sliddele passende til:

# KUHN T underplov

## Bryst- og muldplader

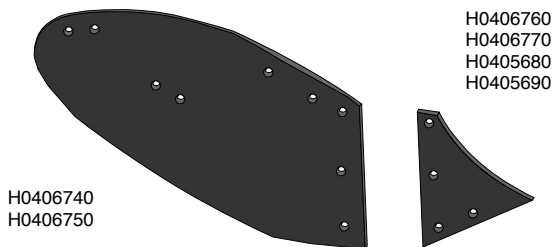

Artikel nr.	Betegnelse	BK.nr.
H0406760	Shin 2015, R	
H0406770	Shin 2015, L	
H0405680	Shin 2014-15 R	
H0405690	Shin 2014-15 L	
H0406740	Mouldboard R	
H0406750	Mouldboard L	

## Skær, spidser og tilbehør

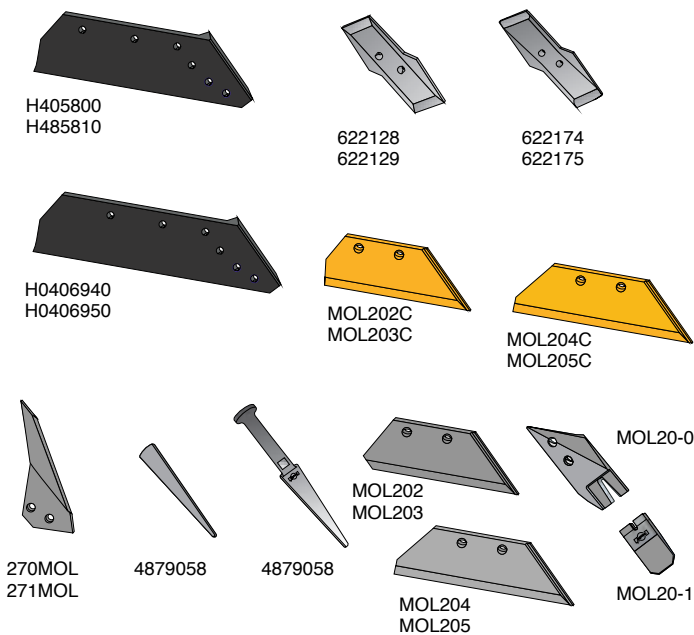

Artikel nr.	Betegnelse	BK.nr.
622174	OLYMPIC POINT R	BK095
622175	OLYMPIC POINT L	BK095
622128	MARATHON POINT R	BK095
622129	MARATHON POINT L	BK095
H405800	EUROSHARE 16" R	
H485810	EUROSHARE 16" L	
H0406940	EUROSHARE 18" R	
H0406950	EUROSHARE 18" L	
MOL202C	EUROCARBIDESHARE M5 16" R	BK165
MOL203C	EUROCARBIDESHARE M5 16" L	BK165
MOL204C	EUROCARBIDESHARE M5 18" R	BK165
MOL205C	EUROCARBIDESHARE M5 18" L	BK165
MOL202	EUROSHARE M5 16" R	BK165
MOL203	EUROSHARE M5 16" L	BK165
MOL204	EUROSHARE M5 18" R	BK165
MOL205	EUROSHARE M5 18" L	BK165
MOL20-0	M7-adapter R	BK166
MOL20-1	M7-adapter V	BK166
MOL83	M7 point rev. R/L	
4879058	Wedge for M7 point	
4879056	Wedge for M7 point	
270MOL	Share knife	BK096
271MOL	Share knife	BK096

## Landsider

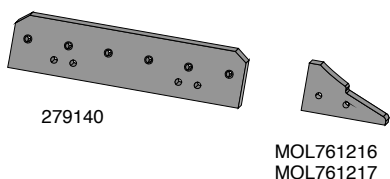

Artikel nr.	Betegnelse	BK.nr.
279140	Landside, rev. R/L	BK099
MOL761216	Skim point R	BK097
MOL761217	Skim point L	BK097



Parts to fit:

## KVERNELAND ploughbody Serie 53

### Shares, points and accessories

Article no.	Designation	BK. no.
53087	Share knife R	BK095
53090	EUROPOINT rev. R	BK094
5309MOLC	EUROCARBIDE M3 point R	BK095
53087	SHARE f/rev.point 14" R	BK100
53088	SHARE f/rev.point 16" R	BK100

### Landside

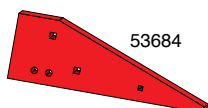

Article no.	Designation	BK. no.
53684	Landside, short R	BK118

### Parts to mount on landsides

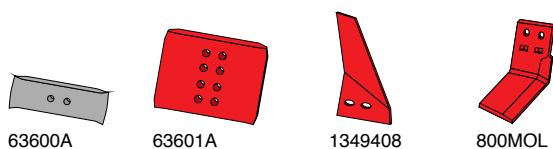

Article no.	Designation	BK. no.
63600A	Wearing plate, rev. R&L	BK094
63601A	Wearing plate, rev. R&L	BK094
1349408	Sword coulter R	BK052
800MOL	Subsoiler blade R	BK096

Parts to fit:

## KVERNELAND ploughbody no. 1 and 3

### Mouldboards, shins and accessories

Article no.	Designation	BK. no.
53387	Turbotrashboard R	BK167
63388	Turbotrashboard L	BK167
73/63-300	Fittings for trashboard R	
73/63-301	Fittings for trashboard L	
53387	Mouldboard extension R	BK082
63388	Mouldboard extension L	BK082
63283	Mouldboard R	BK056
63293	Mouldboard L	BK056
63261	Mouldboard R	BK056
63271	Mouldboard L	BK056
63240	Shin R	BK053
63250	Shin L	BK053

### Shares, points and accessories

Article no.	Designation	BK. no.
063014	EUROSHARE 14" R	BK100
063017	EUROSHARE 14" L	BK100
063015	EUROSHARE 16" R	BK100
063018	EUROSHARE 16" L	BK100
73091	Share knife R	BK096
73092	Share knife L	BK096
53090	EUROPOINT Rev. R	BK094
63090	EUROPOINT Rev. L	BK094
5309MOLC	EUROCARBIDE M3 point R	BK095
6309MOLC	EUROCARBIDE M3 point L	BK095

Parts to fit:

## KVERNELAND ploughbody no. 1 and 3

### Landsides

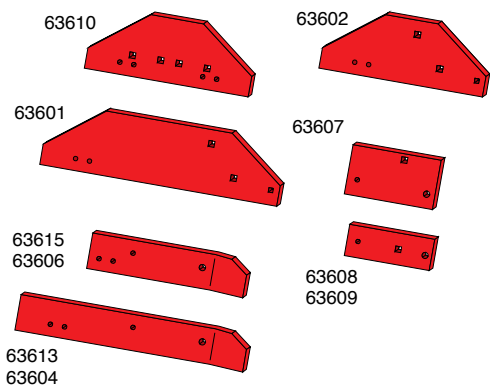

Article no.	Designation	BK. no.
63610	Landside, short R&L	BK128
63615	Landside, short, low R	BK103
63606	Landside, short, low L	BK103
63613	Landside, long, low R	BK103
63604	Landside, long, low L	BK103
63602	Landside, short R	BK118
63601	Landside, long R	BK118
63607	Conversion plate R	BK136
63608	Conversion plate f/rev.plough R	BK136
63609	Conversion plate f/rev.plough L	BK136

### Parts to mount on landsides

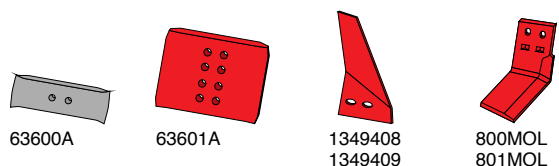

Article no.	Designation	BK. no.
63600A	Wearing plate, rev. R&L	BK094
63601A	Wearing plate, rev. R&L	BK094
1349408	Sword coulter R	BK052
1349409	Sword coulter L	BK052
800MOL	Subsoiler blade R	BK096
801MOL	Subsoiler blade L	BK096

Parts to fit:

## KVERNELAND ploughbody no. 8 and 9

### Mouldboards, shins and accessories

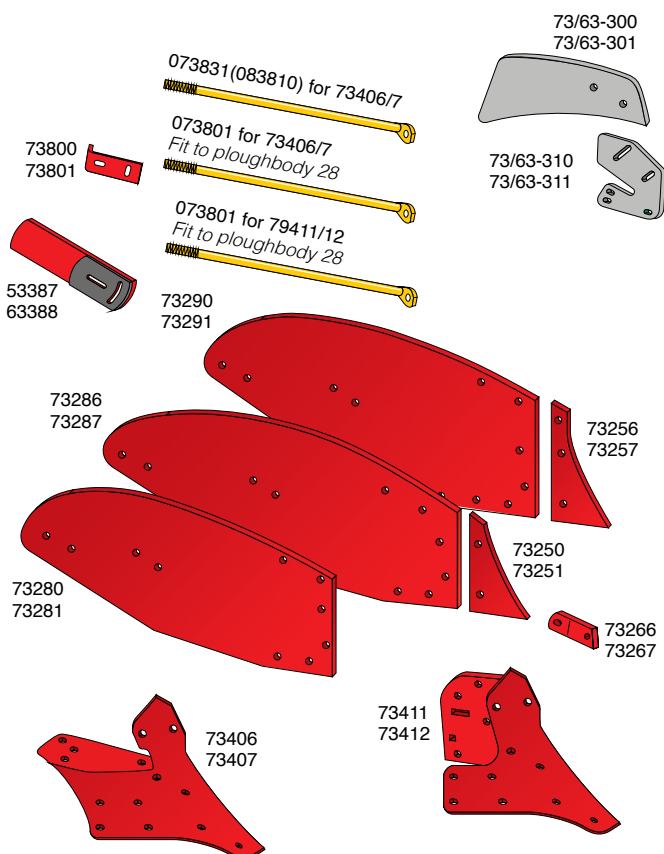

Article no.	Designation	BK. no.
73/63-300	Turbotrashboard R	BK167
73/63-301	Turbotrashboard L	BK167
73/63-310	Fittings for trashboard R	
73/63-311	Fittings for trashboard L	
073801	Brace R&L (for frog 73406/7)	BK156
73803	Brace R&L (for frog 73411/12)	BK156
073831	Brace R&L (for frog 73406/7)	BK156
083810	Brace R&L (for frog 73406/7)	BK156
73800	Brace fitting R	BK113
73801	Brace fitting L	BK113
53387	Mouldboard extension R	BK082
63388	Mouldboard extension L	BK082
73290	Mouldboard R no.9 14"20"	BK059
73291	Mouldboard L no.9 14"20"	BK059
73286	Mouldboard R no.8 14"20"	BK056
73287	Mouldboard L no.8 14"20"	BK056
73280	Mouldboard R no.8 12"	BK056
73281	Mouldboard L no.8 12"	BK056
73256	Shin R	BK154
73257	Shin L	BK154
73250	Shin R	BK058
73251	Shin L	BK058
73266	Bracket for shin R	BK052
73267	Bracket for shin L	BK052
73411	Frog R	
73412	Frog L	
73406	Frog R	
73407	Frog L	

**Do you know...**  
 Molbro's Euroshares gives optimal support to the point and gives the point a unique ability to attack the soil even when it is very dry.

Parts to fit:

# KVERNELAND ploughbody no. 8 and 9

## Shares, points and accessories

Article no.	Designation	BK. no.
073002	EUROSHARE 14" R	BK113
073003	EUROSHARE 14" L	BK113
073004	EUROSHARE 16" R	BK113
073005	EUROSHARE 16" L	BK113
073004-14	EUROSHARE 16" R 14mm	BK178
073005-14	EUROSHARE 16" L 14mm	BK178
073006	EUROSHARE 18" R	BK114
073007	EUROSHARE 18" L	BK114
073008	EUROSHARE 20" R	BK114
073009	EUROSHARE 20" L	BK114
83018	SHARE M5/M7 16" R	BK170
83019	SHARE M5/M7 16" L	BK170
83020	SHARE M5/M7 18" R	BK170
83021	SHARE M5/M7 18" L	BK170
83022	SHARE M5/M7 20" R	BK170
83023	SHARE M5/M7 20" L	BK170
83010C	EUROCARBIDE M5 point R	BK111
83011C	EUROCARBIDE M5 point L	BK111
MOL83-0	M7 adapter R	BK175
MOL83-1	M7 adapter L	BK175
MOL83	M7 point rev. R&L	
4879058	Wedge for M7 point	
4879056	Wedge for M7 point	
73091	Share knife R	BK095
73092	Share knife L	BK095
53090	EUROPOINT Rev. R	BK094
63090	EUROPOINT Rev. L	BK094
5309MOLC	EUROCARBIDE M3 point R	BK095
6309MOLC	EUROCARBIDE M3 point L	BK095
73414	Bracket for 18" and 20" shares R	
73415	Bracket for 18" and 20" shares L	
83018C	EUROCARBIDE M5/M7 share 16" R	BK170
83019C	EUROCARBIDE M5/M7 share 16" L	BK170
83020C	EUROCARBIDE M5/M7 share 18" R	BK170
83021C	EUROCARBIDE M5/M7 share 18" L	BK170
83022C	EUROCARBIDE M5/M7 share 20" R	BK170
83023C	EUROCARBIDE M5/M7 share 20" L	BK170

## Landsides and share knives

Article no.	Designation	BK. no.
73608	Landside, short R&L	BK111
73609	Landside, short R&L	BK111
73088	Share knife R	BK110
73089	Share knife L	BK110
84320	Share knife R	BK110
84321	Share knife L	BK110
73608C	Landside, coated short R&L	BK111
73609C	Landside, coated long R&L	BK111

## Parts to mount on landsides

Article no.	Designation	BK. no.
63600A	Wearing plate, rev. R&L	BK094
63601A	Wearing plate, rev. R&L	BK094
1349408	Sword coulter R	BK052
1349409	Sword coulter L	BK052
800MOL	Subsoiler blade R	BK096
801MOL	Subsoiler blade L	BK096

Parts to fit:

# KVERNELAND ploughbody no. 14

## Shares, points and accessories

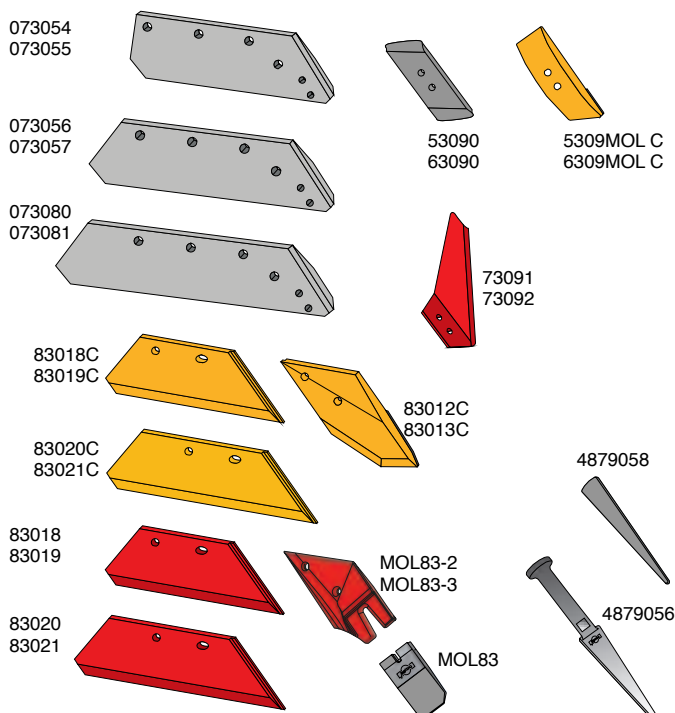

Article no.	Designation	BK. no.
073054	EUROSHARE 14" R	BK113
073055	EUROSHARE 14" L	BK113
073056	EUROSHARE 16" R	BK113
073057	EUROSHARE 16" L	BK113
073080	EUROSHARE 18" R	BK113
073081	EUROSHARE 18" L	BK113
73091	Share knife R	BK096
73092	Share knife L	BK096
53090	EUROPOINT Rev. R	Bk094
63090	EUROPOINT Rev. L	BK094
5309MOLC	EUROCARBIDE M3 point R	BK095
6309MOLC	EUROCARBIDE M3 point L	BK095
83018	SHARE M5/M7 16" R	BK170
83019	SHARE M5/M7 16" L	Bk170
83020	SHARE M5/M7 18" R	BK170
83021	SHARE M5/M7 18" L	BK170
83012C	EUROCARBIDE M5/M7 point R	BK111
83013C	EUROCARBIDE M5/M7 point L	BK111
MOL83-2	M7 adapter R	BK175
MOL83-3	M7 adapter L	BK175
MOL83	M7 point rev. R&L	
4879058	Wedge for M7 point	
4879056	Wedge for M7 point	
83018C	EUROCARBIDE M5/M7 share 16" R	BK170
83019C	EUROCARBIDE M5/M7 share 16" L	BK170
83020C	EUROCARBIDE M5/M7 share 18" R	BK170
83021C	EUROCARBIDE M5/M7 share 18" L	BK170

## Landsides and share knives

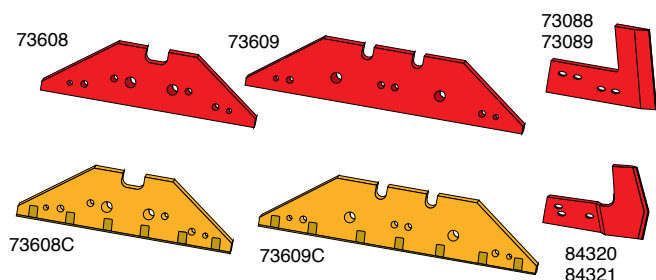

Article no.	Designation	BK. no.
73608	Landside, short R&L	BK111
73609	Landside, long R&L	BK111
73088	Share knife R	BK110
73089	Share knife L	BK110
84320	Share knife R	BK110
84321	Share knife L	BK110
73608C	Landside, coated short R&L	BK111
73609C	Landside, coated long R&L	BK111

## Parts to mount on landsides

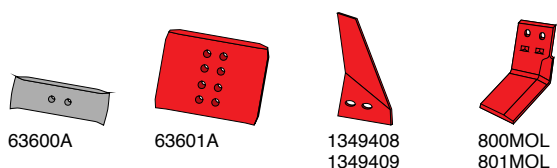

Article no.	Designation	BK. no.
63600A	Wearing plate, rev. R&L	BK094
63601A	Wearing plate, rev. R&L	BK094
1349408	Sword coulter R	BK052
1349409	Sword coulter L	BK052
800MOL	Subsoiler blade R	BK096
801MOL	Subsoiler blade L	BK096

**Do you know...**  
 Molbro's landsides 73608 and 73609 are longer and higher than the original? This gives increased stability of the plough.

Parts to fit:

# KVERNELAND ploughbody no. 28

## Mouldboards, shins and accessories

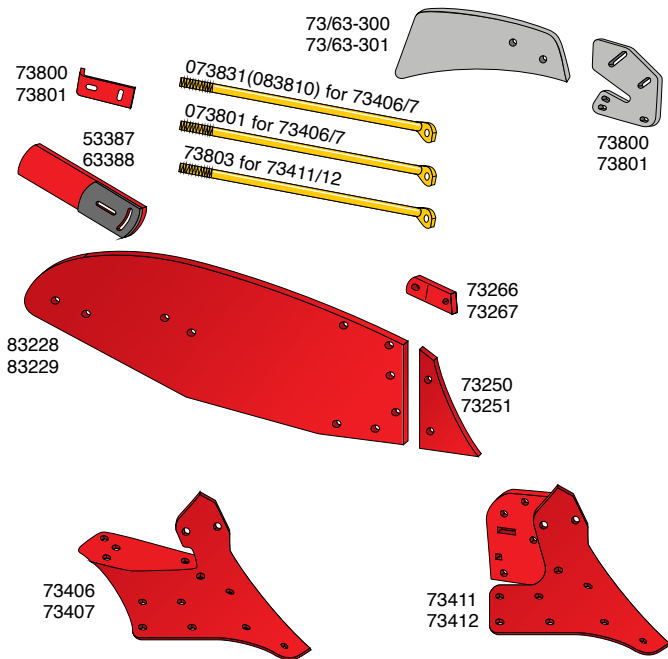

Article no.	Designation	BK. no.
73/63-300	Turbo-trashboard R	BK167
73/63-301	Turbo-trashboard L	BK167
73/63-310	Fittings for trashboard R	
73/63-311	Fittings for trashboard L	
073801	Brace R&L (for frog 73411/12)	BK156
73803	Brace R&L (for frog 73411/12)	BK156
073831	Brace R&L (for frog 73406/7)	BK156
083810	Brace R&L (for frog 73406/7)	BK156
73800	Brace fitting R	BK113
73801	Brace fitting L	BK113
53387	Mouldboard extension R	BK082
63388	Mouldboard extension L	BK082
83228	Mouldboard R no.28 14"-20"	BK154
83229	Mouldboard L no.28 14"-20"	BK154
73250	Shin R	BK052
73251	Shin L	BK052
73266	Bracket for shin R	
73267	Bracket for shin L	
73411	Frog R	
73412	Frog L	
73406	Frog R	
73407	Frog L	

## Shares, points and accessories

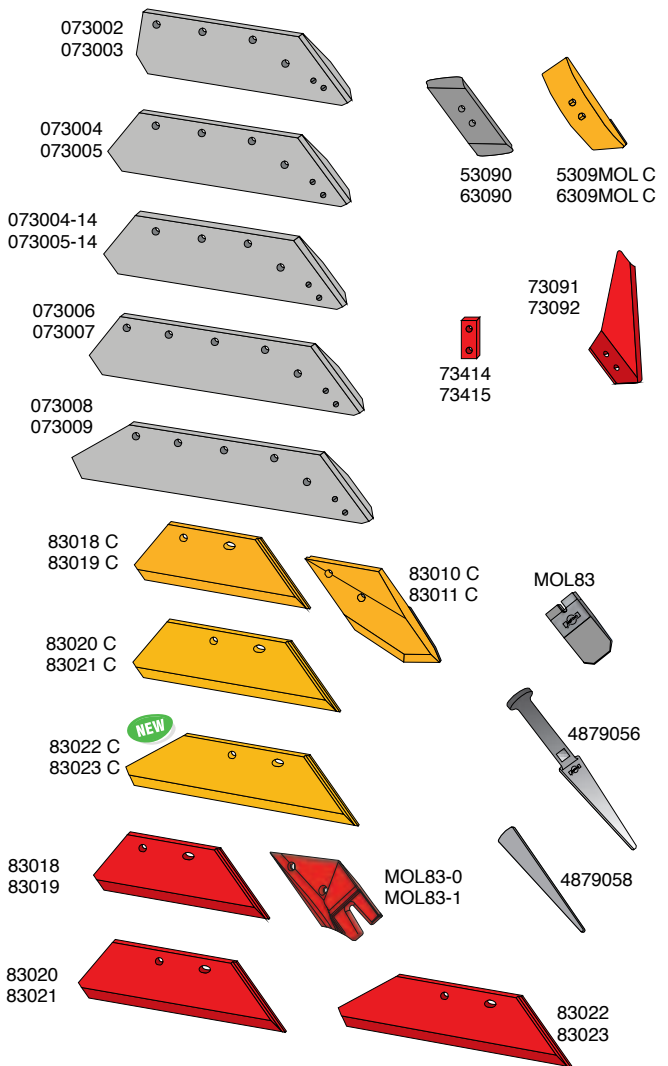

Article no.	Designation	BK. no.
073002	EUROSHARE 14" R	BK113
073003	EUROSHARE 14" L	BK113
073004	EUROSHARE 16" R	BK113
073005	EUROSHARE 16" L	BK113
073004-14	EUROSHARE 16" R 14mm	BK178
073005-14	EUROSHARE 16" L 14mm	BK178
073006	EUROSHARE 18" R	BK114
073007	EUROSHARE 18" L	BK114
073008	EUROSHARE 20" R	BK114
073009	EUROSHARE 20" L	BK114
83018	SHARE M5/M7 16" R	BK170
83019	SHARE M5/M7 16" L	BK170
83020	SHARE M5/M7 18" R	BK170
83021	SHARE M5/M7 18" L	BK170
83022	SHARE M5/M7 20" R	BK170
83023	SHARE M5/M7 20" L	BK170
83010C	EUROCARBIDE M5 point R	BK111
83011C	EUROCARBIDE M5 point L	BK111
MOL83-0	M7 adapter R	BK175
MOL83-1	M7 adapter L	BK175
MOL83	M7 point rev. R&L	
4879058	Wedge for M7 point	
4879056	Wedge for M7 point	
73091	Share knife R	BK095
73092	Share knife L	BK095
53090	EUROPOINT Rev. R	BK094
63090	EUROPOINT Rev. L	BK094
5309MOLC	EUROCARBIDE M3 point R	BK095
6309MOLC	EUROCARBIDE M3 point L	BK095
73414	Bracket for 18" and 20" shares R	
73415	Bracket for 18" and 20" shares L	
83018C	EUROCARBIDE M5/M7 share 16" R	BK170
83019C	EUROCARBIDE M5/M7 share 16" L	BK170
83020C	EUROCARBIDE M5/M7 share 18" R	BK170
83021C	EUROCARBIDE M5/M7 share 18" L	BK170
83022C	EUROCARBIDE M5/M7 share 20" R	BK170
83023C	EUROCARBIDE M5/M7 share 20" L	BK170



Parts to fit:

## KVERNELAND ploughbody no. 28

### Landsides and share knives

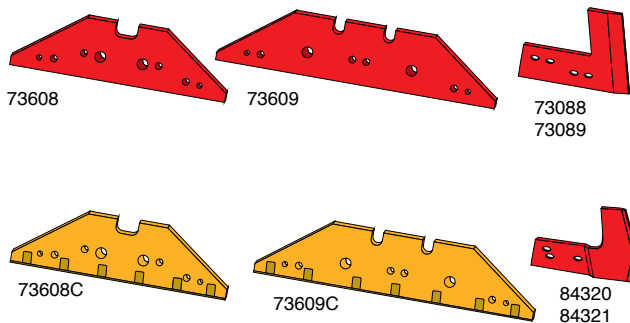

Article no.	Designation	BK. no.
73608	Landside, short R&L	BK111
73609	Landside, long R&L	BK111
73088	Share knife R	BK110
73089	Share knife L	BK110
84320	Share knife R	BK110
84321	Share knife L	BK110

73608C	Landside, coated short R&L	BK111
73609C	Landside, coated long R&L	BK111

### Parts to mount on landsides

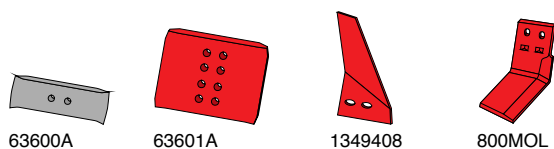

Article no.	Designation	BK. no.
63600A	Wearing plate, rev. R&L	BK094
63601A	Wearing plate, rev. R&L	BK094
1349408	Sword coulter R	BK052
1349409	Sword coulter L	BK052
800MOL	Subsoiler blade R	BK096
801MOL	Subsoiler blade L	BK096

**You can wear out more than six M7 points before the M7 adapter needs replacement.**



Parts to fit:

# KVERNELAND ploughbody no. 12 and 19

## Mouldboards, shins and accessories

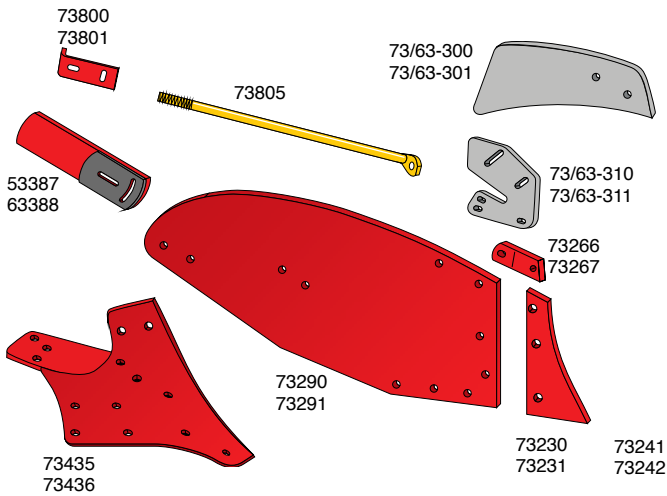

Article no.	Designation	BK. no.
73/63-300	Turbo-trashboard R	BK167
73/63-301	Turbo-trashboard L	BK167
73/63-310	Fittings for trashboard R	
73/63-311	Fittings for trashboard L	
53387	Mouldboard extension R	BK082
63388	Mouldboard extension L	BK082
73290	Mouldboard R	BK059
73291	Mouldboard L	BK059
73800	Brace fitting R	BK113
73801	Brace fitting L	BK113
73805	Brace R&L (for frog 73406/7)	BK156
73230	Shin R	BK058
73231	Shin L	BK058
73266	Bracket for shin R	
73267	Bracket for shin L	
73435	Frog R	
73436	Frog L	

## Shares, points and accessories

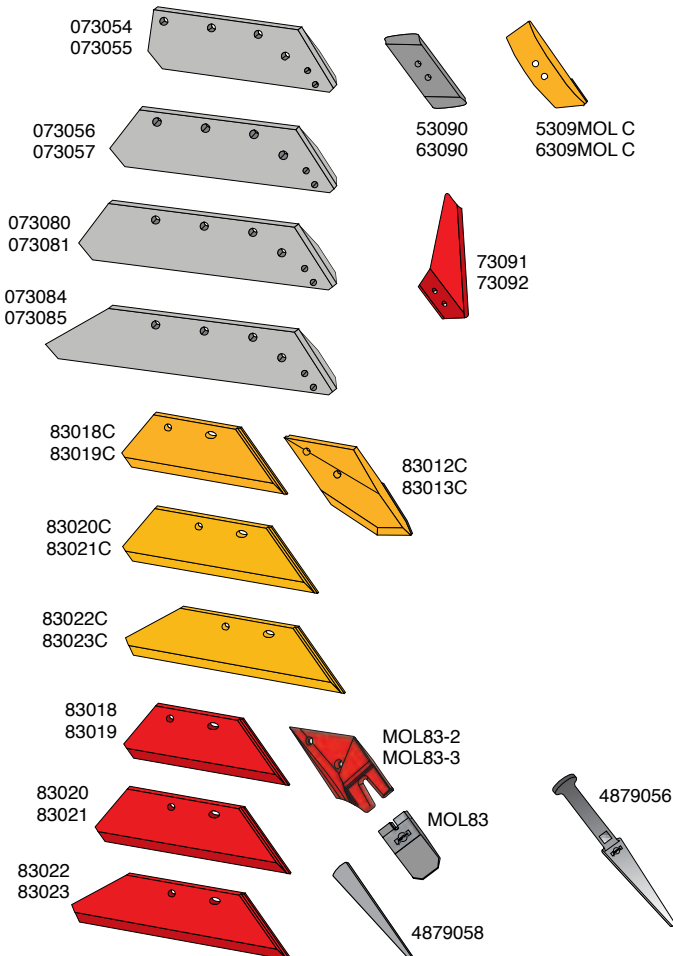

Article no.	Designation	BK. no.
073054	EUROSHARE 14" R	BK113
073055	EUROSHARE 14" L	BK113
073056	EUROSHARE 16" R	BK113
073057	EUROSHARE 16" L	BK113
073080	EUROSHARE 18" R	BK113
073081	EUROSHARE 18" L	BK113
073084	EUROSHARE 20" R	BK113
073085	EUROSHARE 20" L	BK113
73091	Share knife R	BK096
73092	Share knife L	BK096
53090	EUROPOINT Rev. R	BK094
63090	EUROPOINT Rev. L	BK094
5309MOLC	EUROCARBIDE M3 point R	BK095
6309MOLC	EUROCARBIDE M3 point L	BK095
83018	SHARE M5/M7 16" R	BK170
83019	SHARE M5/M7 16" L	BK170
83020	SHARE M5/M7 18" R	BK170
83021	SHARE M5/M7 18" L	BK170
83022	SHARE M5/M7 20" R	BK170
83023	SHARE M5/M7 20" L	BK170
83012C	EUROCARBIDE M5 point R	BK111
83013C	EUROCARBIDE M5 point L	BK111
MOL83-2	M7 adapter R	BK175
MOL83-3	M7 adapter L	BK175
MOL83	M7 point rev. R&L	
4879058	Wedge for M7 point	
4879056	Wedge for M7 point	
83018C	EUROCARBIDE M5/M7 share 16" R	BK170
83019C	EUROCARBIDE M5/M7 share 16" L	BK170
83020C	EUROCARBIDE M5/M7 share 18" R	BK170
83021C	EUROCARBIDE M5/M7 share 18" L	BK170
83022C	EUROCARBIDE M5/M7 share 20" R	BK170
83023C	EUROCARBIDE M5/M7 share 20" L	BK170

Parts to fit:

# KVERNELAND ploughbody no. 12 and 19

## Landsides and share knives

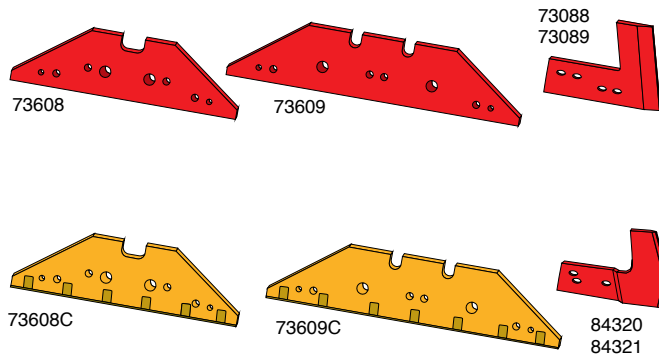

Article no.	Designation	BK. no.
73608	Landside, short R&L	BK111
73609	Landside, long R&L	BK111
73088	Share knife R	BK110
73089	Share knife L	BK110
84320	Share knife R	BK110
84321	Share knife L	BK110
73608C	Landside, coated short R&L	BK111
73609C	Landside, coated long R&L	BK111

## Parts to mount on landsides

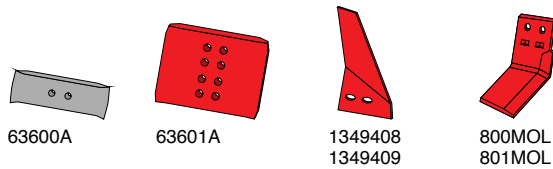

Article no.	Designation	BK. no.
63600A	Wearing plate, rev. R&L	BK094
63601A	Wearing plate, rev. R&L	BK094
1349408	Sword coulter R	BK052
1349409	Sword coulter L	BK052
800MOL	Subsoiler blade R	BK096
801MOL	Subsoiler blade L	BK096

**Do you know...**  
 With Mølbro's conical high-headed bolt  
 you can wear your reversible points  
 down to 4 mm without falling off.

Parts to fit:

# KVERNELAND ploughbody no. 20 and 30

## Shares, points and accessories

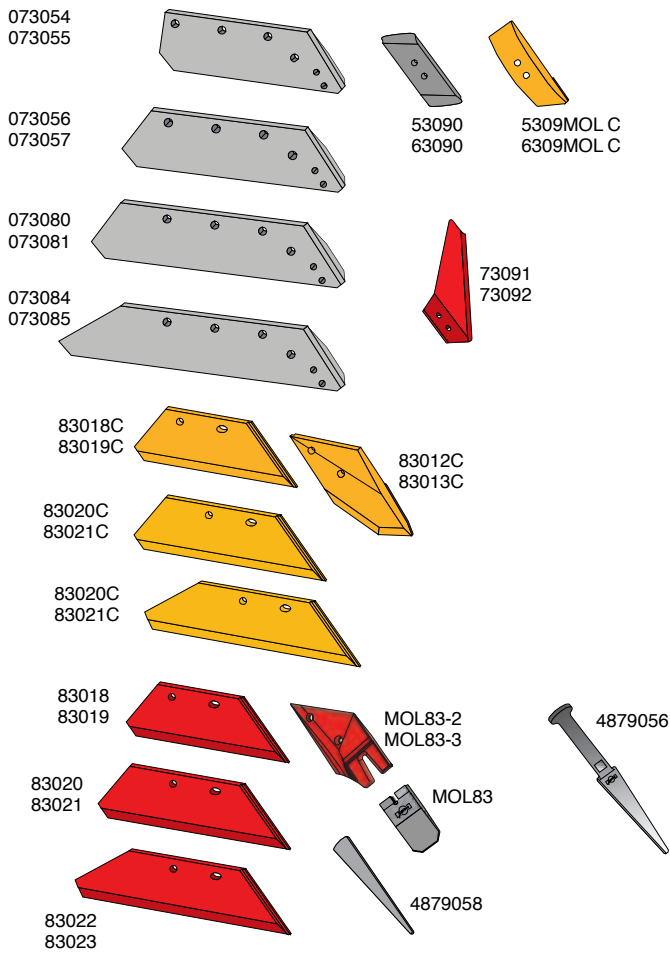

Article no.	Designation	BK. no.
073054	EUROSHARE 14" R	BK113
073055	EUROSHARE 14" L	BK113
073056	EUROSHARE 16" R	BK113
073057	EUROSHARE 16" L	BK113
073080	EUROSHARE 18" R	BK113
073081	EUROSHARE 18" L	BK113
073084	EUROSHARE 20" R	BK113
073085	EUROSHARE 20" L	BK113
73091	Share knife R	BK095
73092	Share knife L	BK095
53090	EUROPOINT Rev. R	BK094
63090	EUROPOINT Rev. L	BK094
5309MOLC	EUROCARBIDE M3 point R	BK095
6309MOLC	EUROCARBIDE M3 point L	BK095
83018	SHARE M5/M7 16" R	BK170
83019	SHARE M5/M7 16" L	BK170
83020	SHARE M5/M7 18" R	BK170
83021	SHARE M5/M7 18" L	BK170
83022	SHARE M5/M7 20" R	BK170
83023	SHARE M5/M7 20" L	BK170
83012C	EUROCARBIDE M5 point R	BK111
83013C	EUROCARBIDE M5 point L	BK111
MOL83-2	M7 adapter R	BK175
MOL83-3	M7 adapter L	BK175
MOL83	M7 point rev. R&L	
4879058	Wedge for M7 point	
4879056	Wedge for M7 point	
83018C	EUROCARBIDE M5/M7 share 16" R	BK170
83019C	EUROCARBIDE M5/M7 share 16" L	BK170
83020C	EUROCARBIDE M5/M7 share 18" R	BK170
83021C	EUROCARBIDE M5/M7 share 18" L	BK170
83020C	EUROCARBIDE M5/M7 share 20" R	BK170
83021C	EUROCARBIDE M5/M7 share 20" L	BK170

## Landsides and share knives

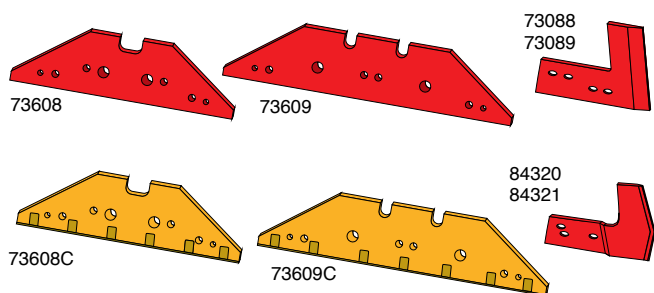

Article no.	Designation	BK. no.
73608	Landside, short R&L	BK111
73609	Landside, long R&L	BK111
73088	Share knife R	BK110
73089	Share knife L	BK110
84320	Share knife R	BK110
84321	Share knife L	BK110
73608C	Landside, coated short R&L	BK111
73609C	Landside, coated long R&L	BK111

## Parts to mount on landsides

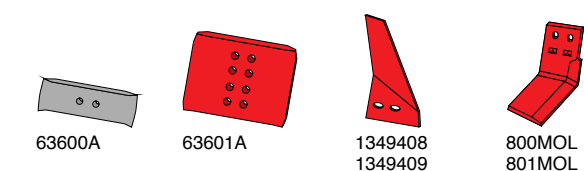

Article no.	Designation	BK. no.
63600A	Wearing plate, rev. R&L	BK094
63601A	Wearing plate, rev. R&L	BK094
1349408	Sword coulter R	BK052
1349409	Sword coulter L	BK052
800MOL	Subsoiler blade R	BK096
801MOL	Subsoiler blade L	BK096

Parts to fit:

# KVERNELAND ploughbody ECOMAT

## Mouldboards

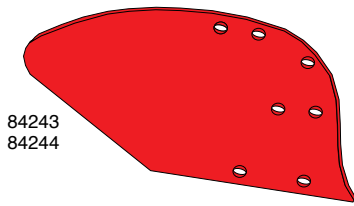

84243  
84244

Article no.	Designation
84243	Mouldboard 14"20" R
84244	Mouldboard 14"20" L

## Shares, points and accessories

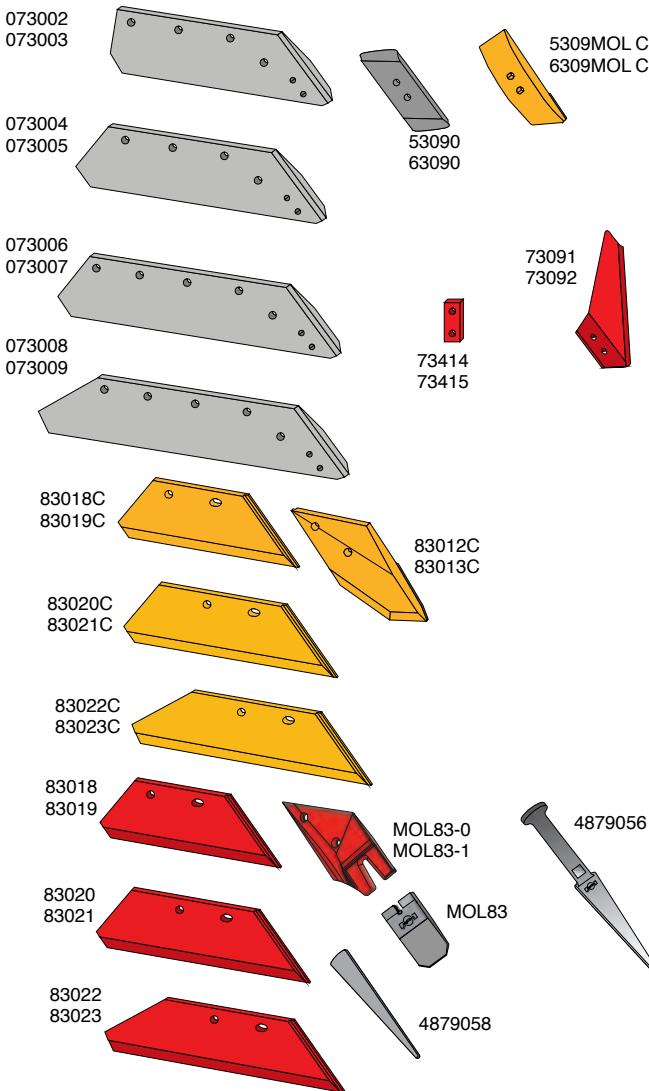

Article no.	Designation	Article no.
073002	EUROSHARE 14" R	BK113
073003	EUROSHARE 14" L	BK113
073004	EUROSHARE 16" R	BK113
073005	EUROSHARE 16" L	BK113
073006	EUROSHARE 18" R	BK114
073007	EUROSHARE 18" L	BK114
073008	EUROSHARE 20" R	BK114
073009	EUROSHARE 20" L	BK114
83018	SHARE M5/M7 16" R	BK170
83019	SHARE M5/M7 16" L	BK170
83020	SHARE M5/M7 18" R	BK170
83021	SHARE M5/M7 18" L	BK170
83022	SHARE M5/M7 20" R	BK170
83023	SHARE M5/M7 20" L	BK170
83010C	EUROCARBIDE M5 point R	BK111
83011C	EUROCARBIDE M5 point L	BK111
MOL83-0	M7 adapter R	BK175
MOL83-1	M7 adapter L	BK175
MOL83	M7 point rev. R&L	
4879058	Wedge for M7 point	
4879056	Wedge for M7 point	
73091	Share knife R	BK095
73092	Share knife L	BK095
53090	EUROPOINT Rev. R	BK094
63090	EUROPOINT Rev. L	BK094
5309MOLC	EUROCARBIDE M3 point R	BK095
6309MOLC	EUROCARBIDE M3 point V	BK095
73414	Bracket for 18" and 20" shares R	
73415	Bracket for 18" and 20" shares L	
83018C	EUROCARBIDE M5/M7 share 16" R	BK170
83019C	EUROCARBIDE M5/M7 share 16" L	BK170
83020C	EUROCARBIDE M5/M7 share 18" R	BK170
83021C	EUROCARBIDE M5/M7 share 18" L	BK170
83022C	EUROCARBIDE M5/M7 share 20" R	BK170
83023C	EUROCARBIDE M5/M7 share 20" L	BK170

## Parts to mount on landsides

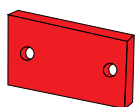

84234

Article no.	Designation	BK. no.
84234	Landside, short R&L	BK111

**Do you know...**  
That the combination of Euroshares and Eurocarbide points means that point and share are evenly worn and hence need replacement at the same time.

Parts to fit:

# KVERNELAND

## Skim shares and skim mouldboards

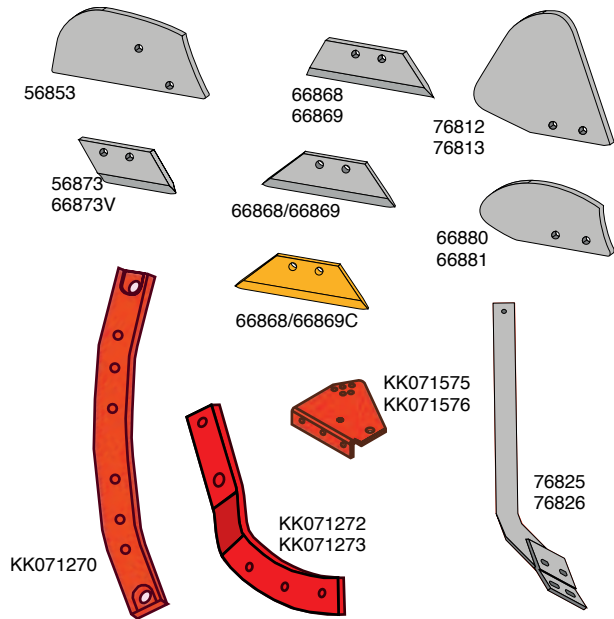

Article no.	Designation	BK. no.
56853	Skim mouldboard R	BK026
76812	Skim mouldboard R	BK026
76813	Skim mouldboard L	BK026
66880	Skim mouldboard R	BK026
66881	Skim mouldboard L	BK026
56873	Skim share, short R	BK004
66873V	Skim share, short L	BK004
66868	Skim share, long R	BK004
66869	Skim share, long L	BK004
66868/66869	Skim share, R&L	BK004
66868/66869C	EUROCARBIDE Skim share, R&L	BK004
76825	Beam R 800mm	
76826	Beam L 800mm	
KK071575	Adapter plade beam bottom	
KK071576	Adapter plade beam top	
KK071270	Beam 800mm center	
KK071272	Beam R	
KK071273	Beam L	

## Disc coulters and accessories

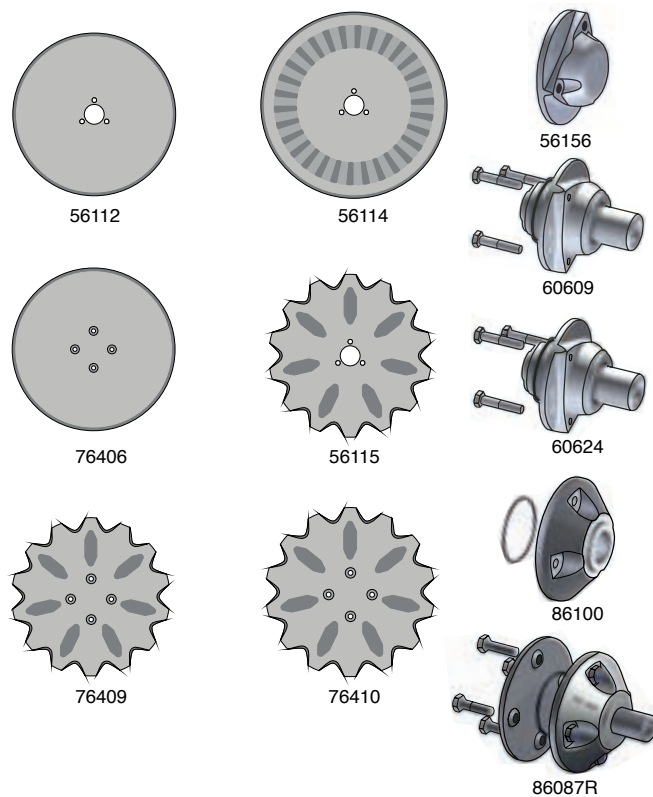

Article no.	Designation
56112	Disc coulters, 16"
56114	Disc coulters, 18"
56115	Disc coulters, rippled 20"
76406	Disc coulters, notched 18"
76409	Disc coulters 18"
76410	Disc coulters 18"
56156	Universal cover for hub
60609	Hub disc coulters Ø34mm
60624	Hub disc coulters Ø30mm
86100	Hub for disc coulters
86087R	Hub disc coulters

Parts to fit:

# LEMKEN B ploughbody

## Mouldboards, shins and accessories

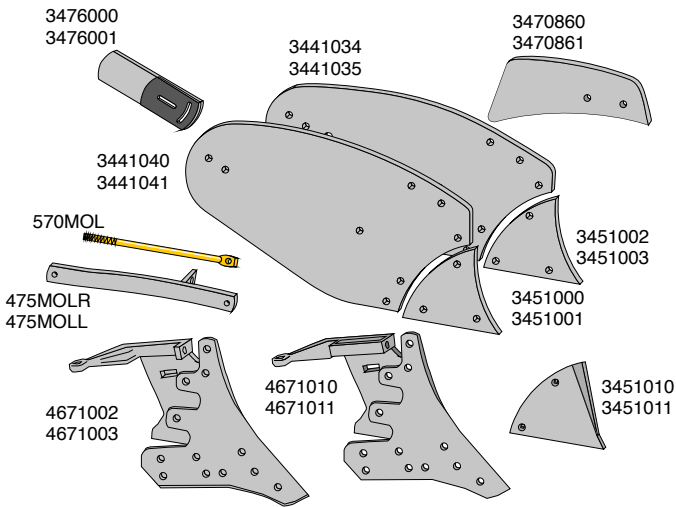

Article no.	Designation	BK. no.
3470860	Turbo-trashboard R	BK009
3470861	Turbo-trashboard L	BK009
3476000	Mouldboard extension R	BK013
3476001	Mouldboard extension L	BK013
3441034	Mouldboard R	BK005
3441035	Mouldboard L	BK005
3441040	Mouldboard R	BK019
3441041	Mouldboard L	BK019
475MOLR	Brace fitting R	
475MOLL	Brace fitting L	
570MOL	Support for mouldboard	
3451000	Shin R	BK007
3451001	Shin L	BK007
3451002	Shin R (10mm)	BK007
3451003	Shin L (10mm)	BK007
3451010	Shin R (8mm)	BK010
3451011	Shin L (8mm)	BK010
4671002	Frog R	BK140
4671003	Frog L	BK140
4671010	Frog R	BK140
4671011	Frog L	BK140

## Share and points

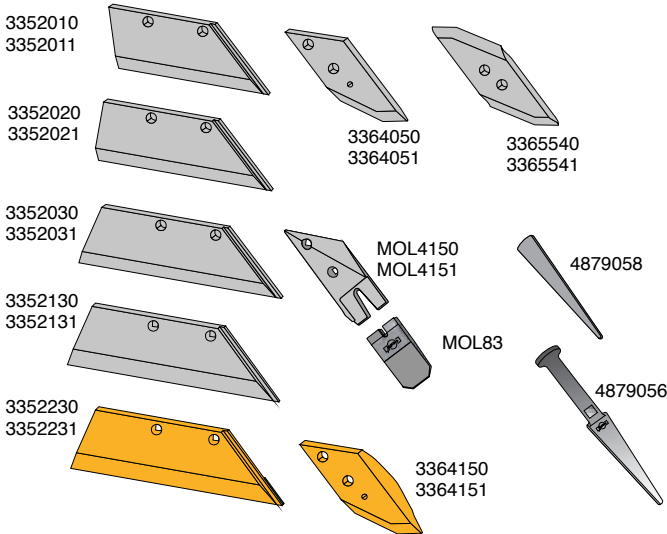

Article no.	Designation	BK. no.
3365540	EUROPOINT rev. R	BK032
3365541	EUROPOINT rev. L	BK032
3364050	EUROPOINT R	BK036
3364051	EUROPOINT L	BK036
3364150	EUROCARBIDE M5 point R	BK036
3364151	EUROCARBIDE M5 point L	BK036
3352010	M5/M7 SHARE 14" R	BK036
3352011	M5/M7 SHARE 14" L	BK036
3352020	M5/M7 SHARE 16" R	BK036
3352021	M5/M7 SHARE 16" L	BK036
3352030	M5/M7 SHARE 18" R	BK036
3352031	M5/M7 SHARE 18" L	BK036
3352130	M5/M7 SHARE 18" R (11mm)	BK036
3352131	M5/M7 SHARE 18" L (11mm)	BK036
3352230	EUROCARBIDE M5/M7 share 18" R	BK036
3352231	EUROCARBIDE M5/M7 share 18" L	BK036
MOL4150	M7 adapter R	BK036
MOL4151	M7 adapter L	BK036
MOL83	M7 point rev. R&L	
4879058	Wedge for M7 point	
4879056	Wedge for M7 point	

## Landsides and share knives

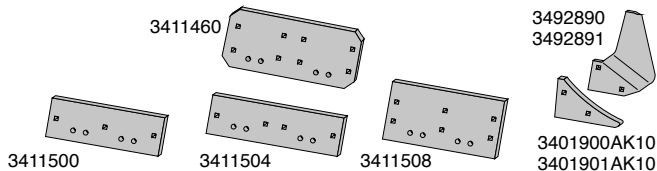

Article no.	Designation	BK. no.
3401900AK10	Landside, front R	BK008
3401901AK10	Landside, front L	BK008
3411500	Landside, short R&L	BK036
3411504	Landside, long R&L	BK036
3411508	Landside, tall R&L	BK037
3411460	Landside, tall R&L	BK037
3492890	Share knife R	BK003
3492891	Share knife L	BK003

## Parts to mount on landsides

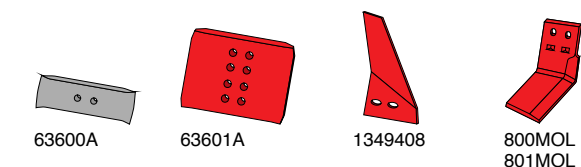

Article no.	Designation	BK. no.
63600A	Wearing plate, rev. R&L	BK094
63601A	Wearing plate, rev. R&L	BK094
1349408	Sword coulter R	BK052
1349409	Sword coulter L	BK052
800MOL	Subsoiler blade R	BK096
801MOL	Subsoiler blade L	BK096



Parts to fit:

# LEMKEN BS 40 ploughbody

## Mouldboards, shins and accessories

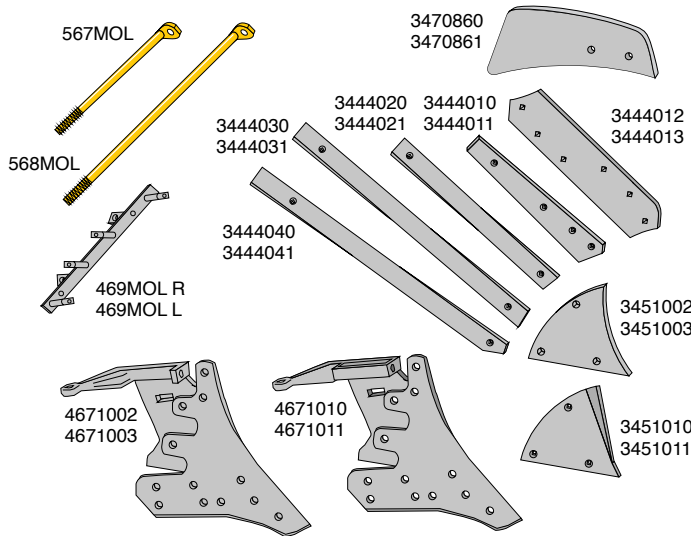

Article no.	Designation	BK. no.
3470860	Turbo-trashboard R	BK009
3470861	Turbo-trashboard L	BK009
469MOL-R	Stay with support R	BK141
469MOL-L	Stay with support L	BK141
567MOL	Support for stay, short	
568MOL	Support for stay, long	
3451002	Shin R (10mm)	BK007
3451003	Shin L (10mm)	BK007
3451010	Shin R (8mm)	BK010
3451011	Shin L (8mm)	BK010
3444010	Mouldboard stripe R	BK172
3444011	Mouldboard stripe L	BK172
3444020	Mouldboard stripe R	BK172
3444021	Mouldboard stripe L	BK172
3444030	Mouldboard stripe R	BK172
3444031	Mouldboard stripe L	BK172
3444040	Mouldboard stripe R	BK172
3444041	Mouldboard stripe L	BK172
3444012	Rev. top stripe R	BK006
3444013	Rev. top stripe L	BK006
4671002	Frog R	BK140
4671003	Frog L	BK140
4671010	Frog R	BK140
4671011	Frog L	BK140

## Share and points

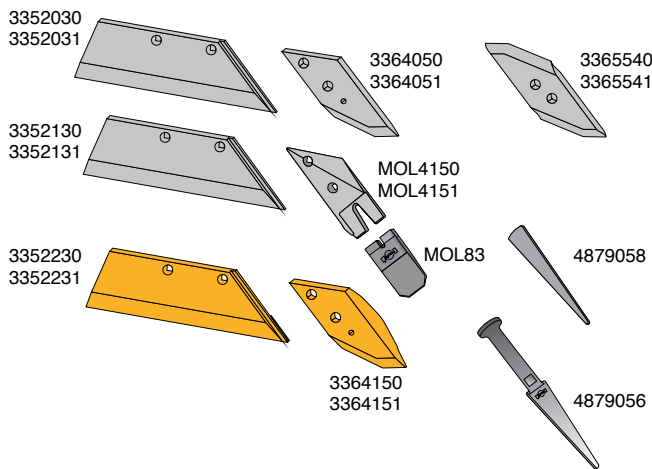

Article no.	Designation	BK. no.
3365540	EUROPOINT rev. R	BK032
3365541	EUROPOINT rev. L	BK032
3364050	EUROPOINT R	BK036
3364051	EUROPOINT L	BK036
3364150	EUROCARBIDE M5 point R	BK036
3364151	EUROCARBIDE M5 point L	BK036
3352030	M5/M7 SHARE 18" R	BK036
3352031	M5/M7 SHARE 18" L	BK036
3352130	M5/M7 SHARE 18" R (11mm)	BK036
3352131	M5/M7 SHARE 18" L (11mm)	BK036
3352230	EUROCARBIDE M5/M7 share 18" R	BK036
3352231	EUROCARBIDE M5/M7 share 18" L	BK036
MOL4150	M7 adapter R	BK036
MOL4151	M7 adapter L	BK036
MOL83	M7 point rev. R&L	
4879058	Wedge for M7 point	
4879056	Wedge for M7 point	

## Landsides and share knives

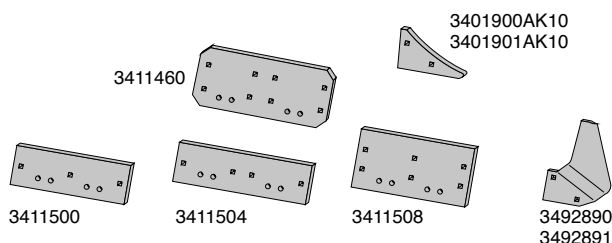

Article no.	Designation	BK. no.
3401900AK10	Landside, front R	BK008
3401901AK10	Landside, front L	BK008
3411500	Landside, short R&L	BK036
3411504	Landside, long R&L	BK036
3411508	Landside, tall R&L	BK037
3411460	Landside, tall R&L	BK037
3492890	Share knife R	BK003
3492891	Share knife L	BK003

## Parts to mount on landsides

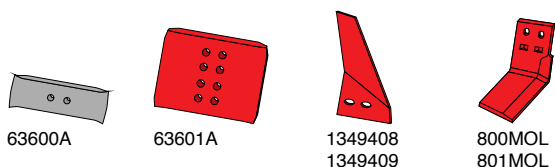

Article no.	Designation	BK. no.
63600A	Wearing plate, rev. R&L	BK094
63601A	Wearing plate, rev. R&L	BK094
1349408	Sword coulters R	BK052
1349409	Sword coulters L	BK052
800MOL	Subsoiler blade R	BK096
801MOL	Subsoiler blade L	BK096

Parts to fit:

# LEMKEN BS 42 ploughbody

## Mouldboards, shins and accessories

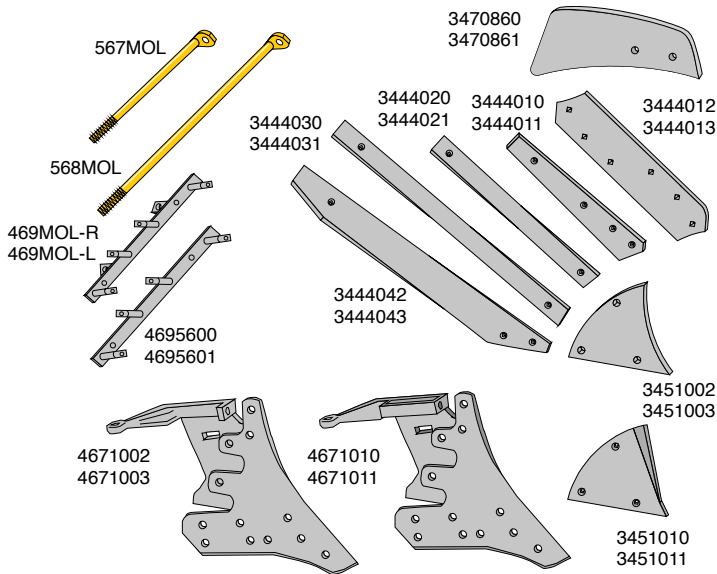

Article no.	Designation	BK. no.
3470860	Turbotrashboard R	BK009
3470861	Turbotrashboard L	BK009
469MOL-R	Stay with support R	BK141
469MOL-L	Stay with support L	BK141
4695600	Stay R	
4695601	Stay L	
567MOL	Support for stay, short	
568MOL	Support for stay, long	
3451002	Shin R (10mm)	BK007
3451003	Shin L (10mm)	BK007
3451010	Shin R (8mm)	BK010
3451011	Shin L (8mm)	BK010
3444010	Mouldboard stripe R	BK172
3444011	Mouldboard stripe L	BK172
3444020	Mouldboard stripe R	BK172
3444021	Mouldboard stripe L	BK172
3444030	Mouldboard stripe R	BK172
3444031	Mouldboard stripe L	BK172
3444042	Mouldboard stripe R	BK173
3444043	Mouldboard stripe L	BK173
3444012	Rev. top stripe R	BK006
3444013	Rev. top stripe L	BK006
4671002	Frog R	BK140
4671003	Frog L	BK140
4671010	Frog R	BK140
4671011	Frog L	BK140

## Share and points

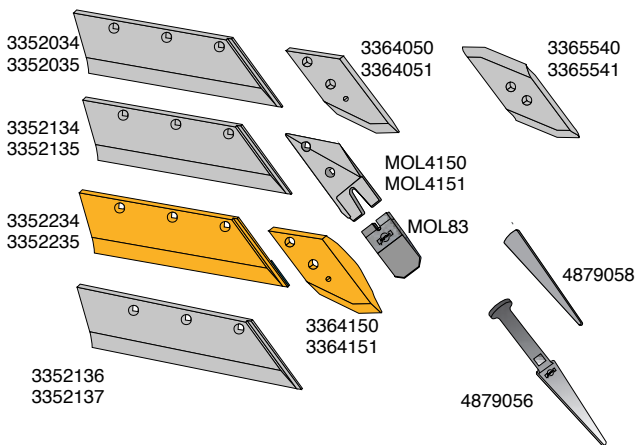

Article no.	Designation	BK. no.
3365540	EUROPOINT rev. R	BK032
3365541	EUROPOINT rev. L	BK032
3364050	EUROPOINT R	BK036
3364051	EUROPOINT L	BK036
3364150	EUROCARBIDE M5 point R	BK036
3364151	EUROCARBIDE M5 point L	BK036
3352034	M5/M7 SHARE 18" R	BK037
3352035	M5/M7 SHARE 18" L	BK037
3352134	M5/M7 SHARE 18" R (11mm)	BK037
3352135	M5/M7 SHARE 18" L (11mm)	BK037
3352234	EUROCARBIDE M5 share 18" R	BK037
3352235	EUROCARBIDE M5 share 18" L	BK037
3352136	EUROSHARE M5 20" R	BK037
3352137	EUROSHARE M5 20" L	BK037
MOL4150	M7 adapter R	BK036
MOL4151	M7 adapter L	BK036
MOL83	M7 point rev. R&L	
4879058	Wedge for M7 point	
4879056	Wedge for M7 point	

## Landsides and share knives

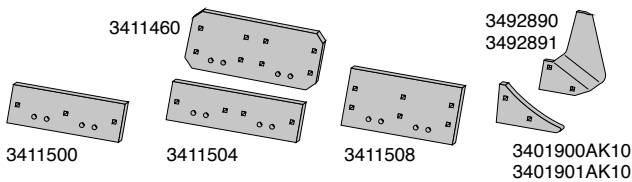

Article no.	Designation	BK. no.
3401900AK10	Landside, front R	BK008
3401901AK10	Landside, front L	BK008
3411500	Landside, short R&L	BK036
3411504	Landside, long R&L	BK036
3411508	Landside, tall R&L	BK037
3411460	Landside, tall R&L	BK037
3492890	Share knife R	BK003
3492891	Share knife L	BK003

## Parts to mount on landsides

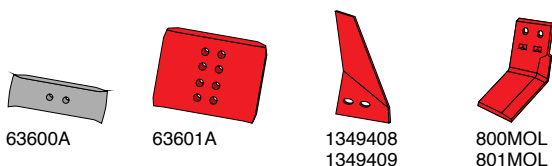

Article no.	Designation	BK. no.
63600A	Wearing plate, rev. R&L	BK094
63601A	Wearing plate, rev. R&L	BK094
1349408	Sword coulter R	BK052
1349409	Sword coulter L	BK052
800MOL	Subsoiler blade R	BK096
801MOL	Subsoiler blade L	BK096

Parts to fit:

## LEMKEN BU ploughbody

### Share and points

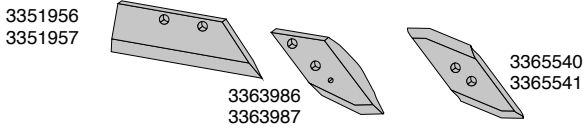

Article no.	Designation	BK. no.
3351956	SHARE 14" R	BK036
3351957	SHARE 14" L	BK036
3363986	EUROPOINT rev. R	BK036
3363987	EUROPOINT rev. L	BK036
3365540	EUROPOINT R	BK032
3365541	EUROPOINT L	BK032

### Landside

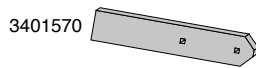

Article no.	Designation	BK. no.
3401570	Landside, semilong R&L	BK044

Parts to fit:

## LEMKEN CS Duramaxx ploughbody

### Landsides

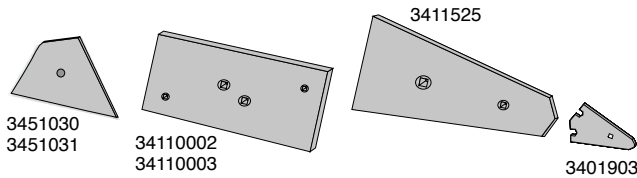

Article no.	Designation
3451030	Shin R (kit with bolts)
3451031	Shin L (kit with bolts)
34110002	Landside R
34110003	Landside L
3411525	Landside R&L
3401903	Landside, front R&L

Parts to fit:

## LEMKEN

### Skim shares and skim mouldboards

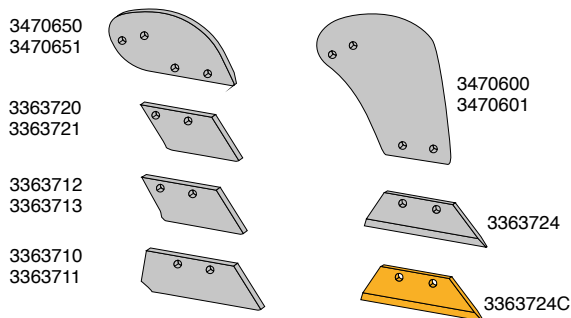

Article no.	Designation	BK. no.
3470650	Skim mouldboard R	BK001
3470651	Skim mouldboard L	BK001
3363720	Skim share R	BK003
3363721	Skim share L	BK003
3363710	Skim share R	BK003
3363711	Skim share L	BK003
3363712	Skim share R	BK003
3363713	Skim share L	BK003
3470600	Skim mouldboard R	BK001
3470601	Skim mouldboard L	BK001
3363724	Skim share R&L	BK003
3363724C	EUROCARBIDE Skim share R&L	BK003

### Disc coulters

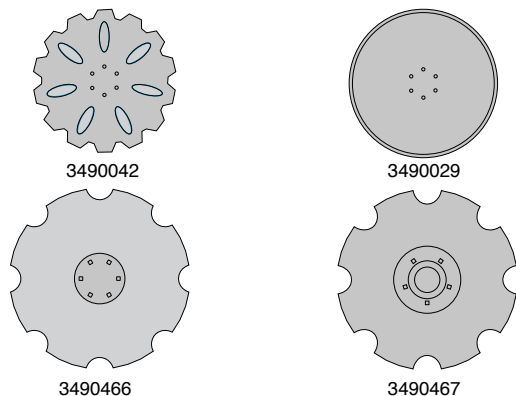

Article no.	Designation
3490042	Disc coulters, notched Ø500mm
3490029	Disc coulters, plain Ø500mm
3490466	Disc coulters, concave, notched Ø625mm
3490467	Disc coulters, concave, notched Ø625mm

Parts to fit:

# LEMKEN C and C40 ploughbody

## Mouldboards, shins and accessories

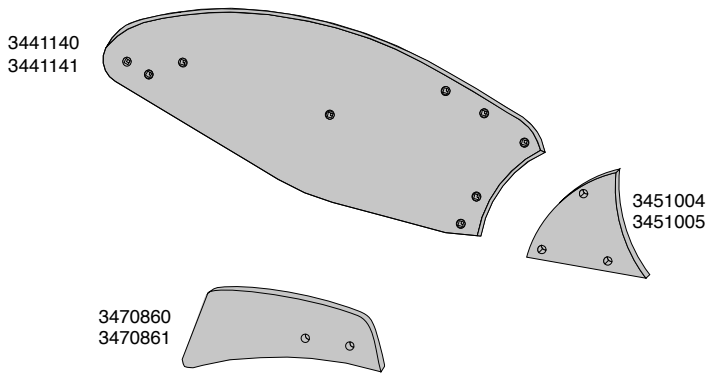

Article no.	Designation	BK. no.
3441140	Mouldboard R	BK005
3441141	Mouldboard L	BK005
3451004	Shin R	BK007
3451005	Shin L	BK007
3470860	Turbotrashboard R	BK009
3470861	Turbotrashboard L	BK009

## Share and points

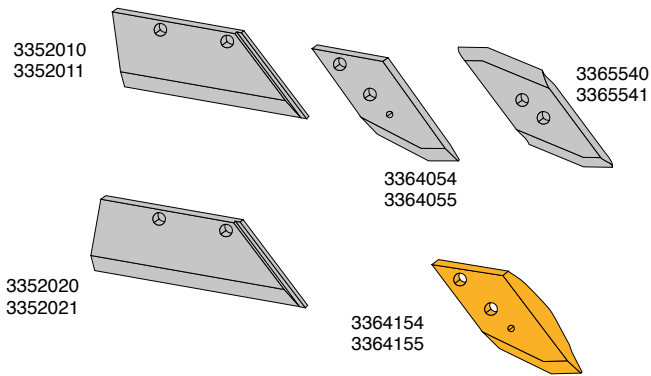

Article no.	Designation	BK. no.
3365540	EUROPOINT rev. R	BK032
3365541	EUROPOINT rev. L	BK032
3364054	EUROPOINT R	BK036
3364055	EUROPOINT L	BK036
3364154	EUROCARBIDE M5 point R	BK036
3364155	EUROCARBIDE M5 point L	BK036
3352010	SHARE M5/M7 14" R	BK036
3352011	SHARE M5/M7 14" L	BK036
3352020	SHARE M5/M7 16" R	BK036
3352021	SHARE M5/M7 16" L	BK036

## Landsides and share knives

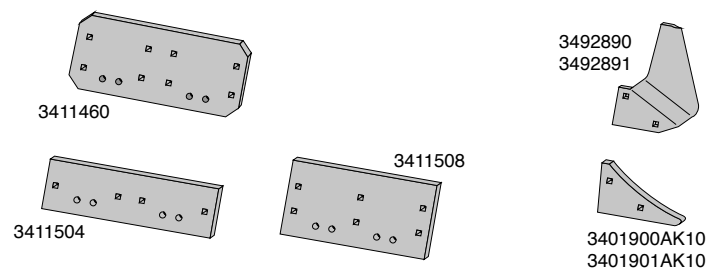

Article no.	Designation	BK. no.
3401900AK10	Landside, front R	BK008
3401901AK10	Landside, front L	BK008
3411508	Landside, tall R&L	BK037
3411504	Landside, long R&L	BK036
3411460	Landside, tall R&L	BK037
3492890	Share knife R	BK003
3492891	Share knife L	BK003

## Parts to mount on landsides

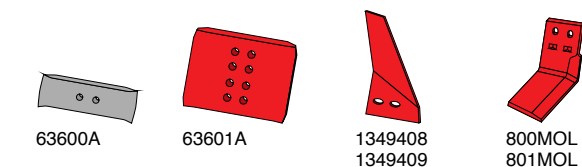

Article no.	Designation	BK. no.
63600A	Wearing plate, rev. R&L	BK094
63601A	Wearing plate, rev. R&L	BK094
1349408	Sword coulter R	BK052
1349409	Sword coulter L	BK052
800MOL	Subsoiler blade R	BK096
801MOL	Subsoiler blade L	BK096

Parts to fit:

# LEMKEN US 35 ploughbody

## Mouldboards, shins and accessories

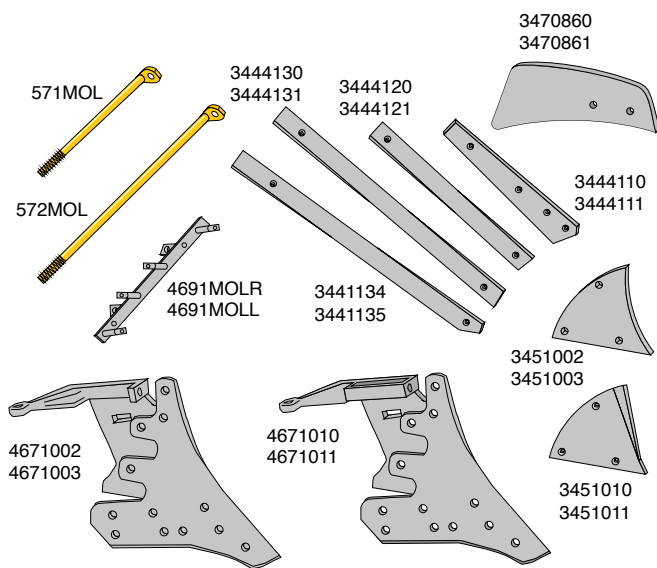

Article no.	Designation	BK. no.
3470860	Turbo-trashboard R	BK009
3470861	Turbo-trashboard L	BK009
4691MOLR	Stay with support R	
4691MOLL	Stay with support L	
571MOL	Support for stay, short	
572MOL	Support for stay, long	
3451002	Shin R (10mm)	BK007
3451003	Shin L (10mm)	BK007
3451010	Shin R (8mm)	BK010
3451011	Shin L (8mm)	BK010
3444110	Mouldboard stripe R	BK006
3444111	Mouldboard stripe L	BK006
3444120	Mouldboard stripe R	BK172
3444121	Mouldboard stripe L	BK172
3444130	Mouldboard stripe R	BK172
3444131	Mouldboard stripe L	BK172
3444134	Mouldboard stripe R	BK172
3444135	Mouldboard stripe L	BK172
4671002	Frog R	BK140
4671003	Frog L	BK140
4671010	Frog R	BK140
4671011	Frog L	BK140

## Share and points

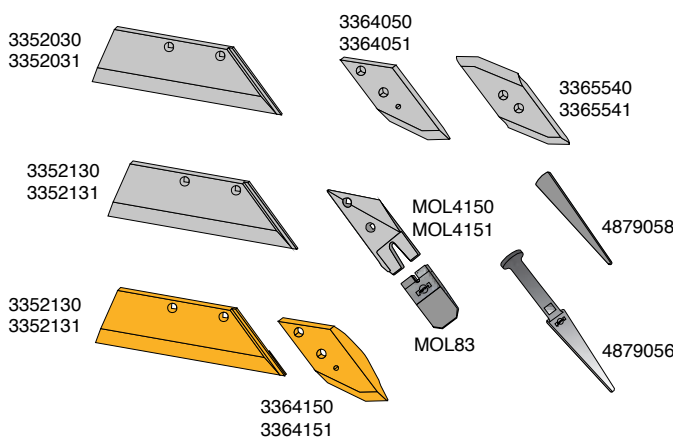

Article no.	Designation	BK. no.
3365540	EUROPOINT rev. R	BK032
3365541	EUROPOINT rev. L	BK032
3364050	EUROPOINT R	BK036
3364051	EUROPOINT L	BK036
3364150	EUROCARBIDE M5 point R	BK036
3364151	EUROCARBIDE M5 point L	BK036
3352030	M5/M7 SHARE 18" R	BK036
3352031	M5/M7 SHARE 18" L	BK036
3352130	M5/M7 SHARE 18" R (11mm)	BK036
3352131	M5/M7 SHARE 18" L (11mm)	BK036
3352230	EUROCARBIDE M5/M7 share 18" R	BK036
3352231	EUROCARBIDE M5/M7 share 18" L	BK036
MOL4150	M7 adapter R	BK036
MOL4151	M7 adapter L	BK036
MOL83	M7 point rev. R&L	
4879058	Wedge for M7 point	
4879056	Wedge for M7point	

## Landsides and share knives

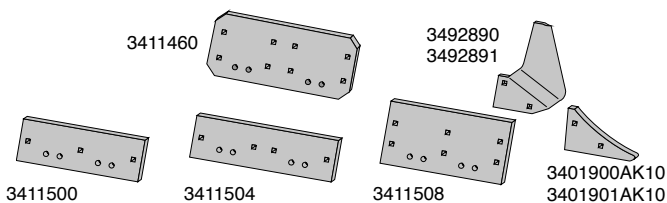

Article no.	Designation	BK. no.
3401900AK10	Landside, front R	BK008
3401901AK10	Landside, front L	BK008
3411500	Landside, short R&L	BK036
3411504	Landside, long R&L	BK036
3411508	Landside, tall R&L	BK037
3411460	Landside, tall R&L	BK037
3492890	Share knife R	BK003
3492891	Share knife L	BK003

## Parts to mount on landsides

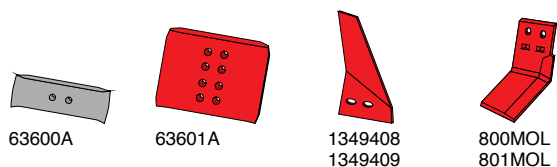

Article no.	Designation	BK. no.
63600A	Wearing plate, rev. R&L	BK094
63601A	Wearing plate, rev. R&L	BK094
1349408	Sword coultter R	BK052
1349409	Sword coultter L	BK052
800MOL	Subsoiler blade R	BK096
801MOL	Subsoiler blade L	BK096



Parts to fit:

# LEMKEN US 40 ploughbody

## Mouldboards, shins and accessories

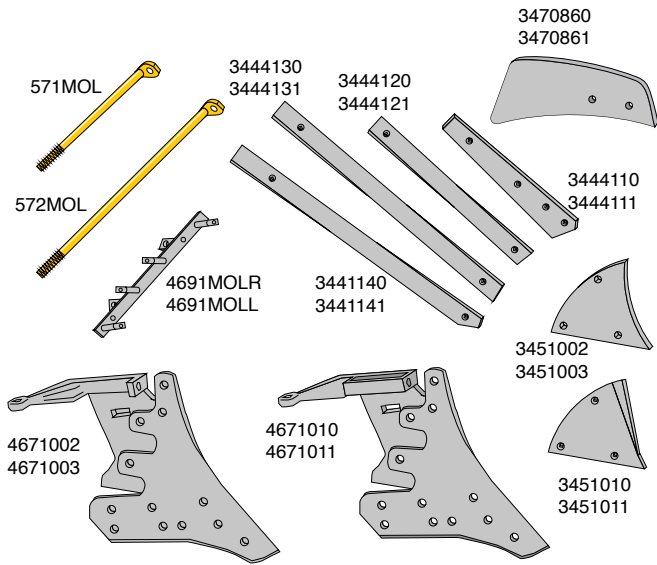

Article no.	Designation	BK. no.
3470860	Turbo-trashboard R	BK009
3470861	Turbo-trashboard L	BK009
4691MOLR	Stay with support R	
4691MOLL	Stay with support L	
571MOL	Support for stay, short	
572MOL	Support for stay, long	
3451002	Shin R (10mm)	BK007
3451003	Shin L (10mm)	BK007
3451010	Shin R (8mm)	BK010
3451011	Shin L (8mm)	BK010
3444110	Mouldboard stripe R	BK006
3444111	Mouldboard stripe L	BK006
3444120	Mouldboard stripe R	BK172
3444121	Mouldboard stripe L	BK172
3444130	Mouldboard stripe R	BK172
3444131	Mouldboard stripe L	BK172
3444140	Mouldboard stripe R	BK173
3444141	Mouldboard stripe L	BK173
4671002	Frog R	BK140
4671003	Frog L	BK140
4671010	Frog R	BK140
4671011	Frog L	BK140

## Share and points

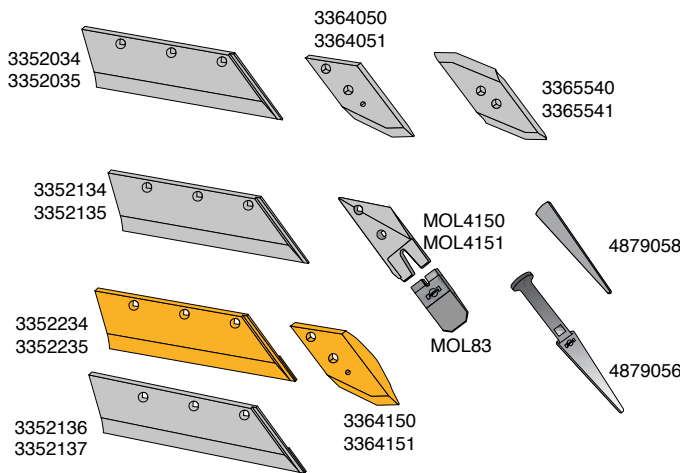

Article no.	Designation	BK. no.
3365540	EUROPOINT rev. R	BK032
3365541	EUROPOINT rev. L	BK032
3364050	EUROPOINT R	BK036
3364051	EUROPOINT L	BK036
3364150	EUROCARBIDE M5 point R	BK036
3364151	EUROCARBIDE M5 point L	BK036
3352034	M5/M7 SHARE 18" R	BK037
3352035	M5/M7 SHARE 18" L	BK037
3352134	M5/M7 SHARE 18" R (11mm)	BK037
3352135	M5/M7 SHARE 18" L (11mm)	BK037
3352234	EUROCARBIDE M5/M7 share 18" R	BK037
3352235	EUROCARBIDE M5/M7 share 18" L	BK037
3352136	SHARE M5/M7 20" R	BK037
3352137	SHARE M5/M7 20" L	BK037
MOL4150	M7 adapter R	BK036
MOL4151	M7 adapter L	BK036
MOL83	M7 point rev. R&L	
4879058	Wedge for M7 point	
4879056	Wedge for M7 point	

## Landsides and share knives

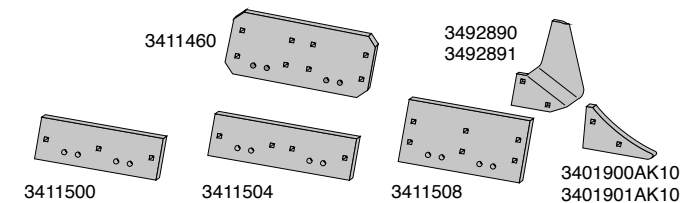

Article no.	Designation	BK. no.
3401900AK10	Landside, front R	BK008
3401901AK10	Landside, front L	BK008
3411500	Landside, short R&L	BK036
3411504	Landside, long R&L	BK036
3411508	Landside, tall R&L	BK037
3411460	Landside, tall R&L	BK037
3492890	Share knife R	BK003
3492891	Share knife L	BK003

## Parts to mount on landsides

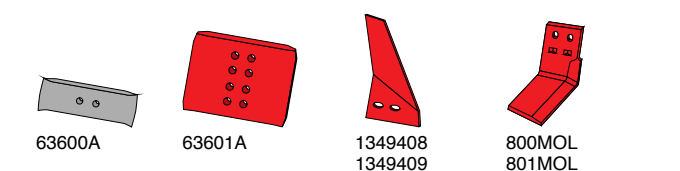

Article no.	Designation	BK. no.
63600A	Wearing plate, rev. R&L	BK094
63601A	Wearing plate, rev. R&L	BK094
1349408	Sword coulters R	BK052
1349409	Sword coulters L	BK052
800MOL	Subsoiler blade R	BK096
801MOL	Subsoiler blade L	BK096



Parts to fit:

## LEMKEN WG ploughbody

### Share and points

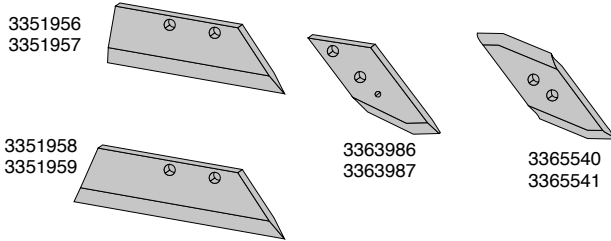

Article no.	Designation	BK. no.
3365540	EUROPOINT rev. R	BK032
3365541	EUROPOINT rev. L	BK032
3363986	EUROPOINT R	BK036
3363987	EUROPOINT L	BK036
3351956	SHARE 14" R	BK036
3351957	SHARE 14" L	BK036
3351958	SHARE 16" R	BK036
3351959	SHARE 16" L	BK036

### Landside

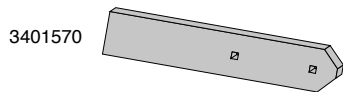

Article no.	Designation	BK. no.
3401570	Landside, semi long R&L	BK044

Parts to fit:

## LEMKEN OPAL ploughbody

### Beams and accessories

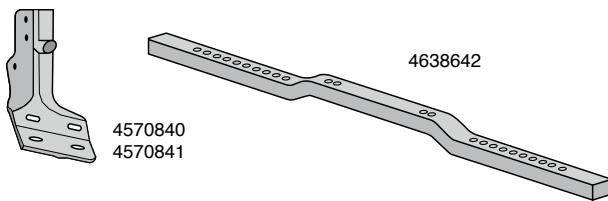

Article no.	Designation
4570840	Frog L
4570841	Frog R
4638642	Beam L&R

Parts to fit:

## LEMKEN WS ploughbody

### Points



Article no.	Designation	BK. no.
3365540	EUROPOINT rev. R	BK032
3365541	EUROPOINT rev. L	BK032
3363980	EUROPOINT R	BK036
3363981	EUROPOINT L	BK036

### Landsides

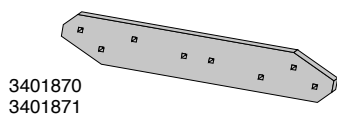

Article no.	Designation	BK. no.
3401870	Landside, semilong R	BK038
3401871	Landside, semilong L	BK038

Parts to fit:

# NAUD

## Share and points

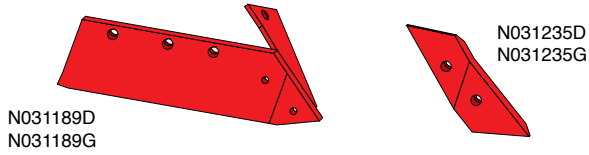

Article no.	Designation
N031189D	SHARE R
N031189G	SHARE L
N031235D	EUROPOINT R
N031235G	EUROPOINT L

## Landsides and share knives

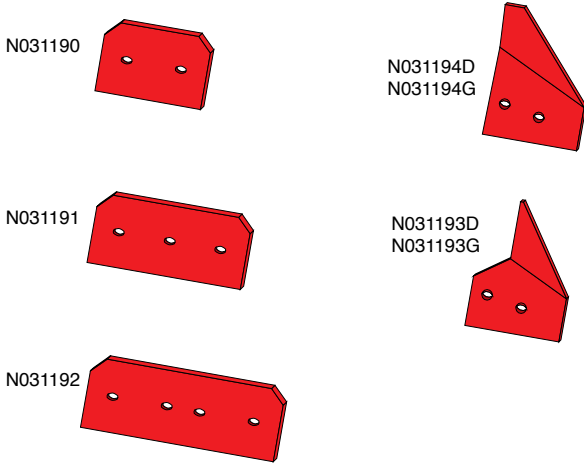

Article no.	Designation
N031190	Landside R&L
N031191	Landside R&L
N031192	Landside R&L
N031193D	Share knife R
N031193G	Share knife L
N031194D	Share knife R
N031194G	Share knife L

## Skim shares



Article no.	Designation
N031241D	Skim share R
N031241G	Skim share L

Parts to fit:

# NIEMEYER

## Share and points

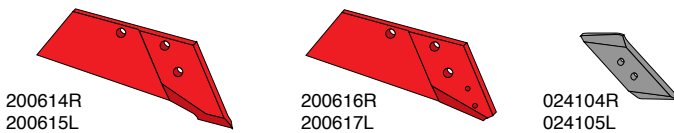

Article no.	Designation	BK. no.
200614R	SHARE R	BK037
200615L	SHARE L	BK037
200616R	SHARE f/rev. point R	BK037
200617L	SHARE f/rev. point L	BK037
024104R	EUROPOINT, rev. R	BK094
024105L	EUROPOINT, rev. L	BK094

Parts to fit:

# PÖTTINGER ploughbody 36W and 41W

## Mouldboards, shins and accessories

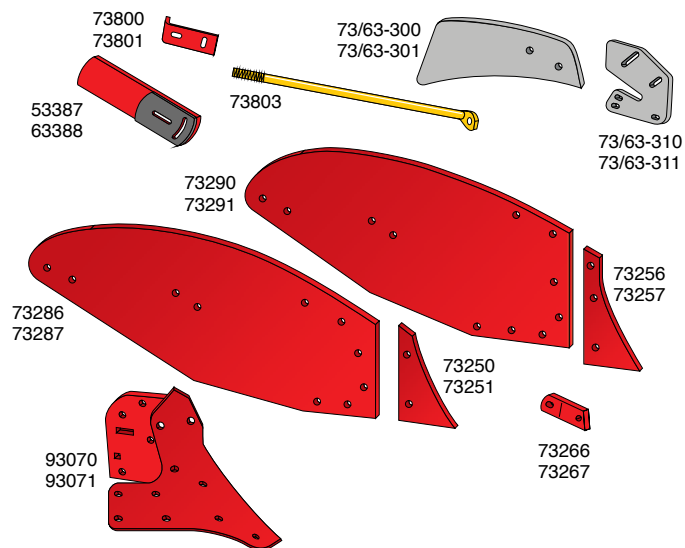

Article no.	Designation	BK. no.
73/63-300	Turbo-trashboard R	BK167
73/63-301	Turbo-trashboard L	BK167
73/63-310	Fittings for trashboard R	
73/63-311	Fittings for trashboard L	
73803	Brace R&L	BK156
73800	Brace fitting R	BK113
73801	Brace fitting L	BK113
53387	Mouldboard extension R	BK082
63388	Mouldboard extension L	BK082
73290	Mouldboard R	BK059
73291	Mouldboard L	BK059
73286	Mouldboard R	BK056
73287	Mouldboard L	BK056
73256	Shin R	BK058
73257	Shin L	BK058
73250	Shin R	BK052
73251	Shin L	BK052
73266	Bracket for shin R	
73267	Bracket for shin L	
93070	Frog R	
93071	Frog L	

## Shares, points and accessories

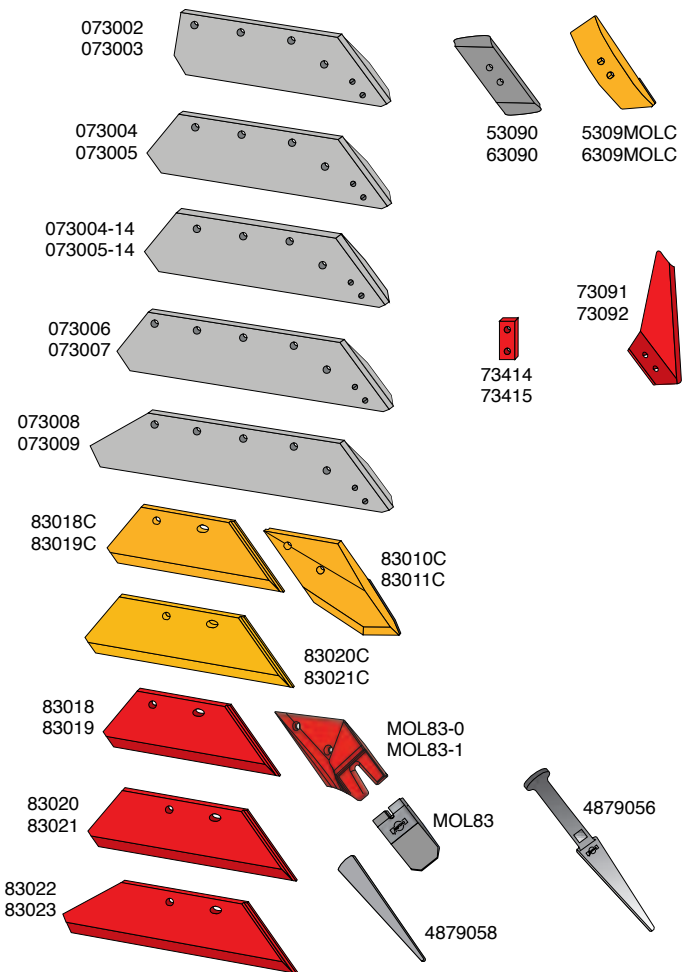

Article no.	Designation	BK. no.
073002	EUROSHARE 14" R	BK113
073003	EUROSHARE 14" L	BK113
073004	EUROSHARE 16" R	BK113
073005	EUROSHARE 16" L	BK113
073004-14	EUROSHARE 16" R 14mm	BK178
073005-14	EUROSHARE 16" L 14mm	BK178
073006	EUROSHARE 18" R	BK114
073007	EUROSHARE 18" L	BK114
073008	EUROSHARE 20" R	BK114
073009	EUROSHARE 20" L	BK114
83018	SHARE M5/M7 16" R	BK170
83019	SHARE M5/M7 16" L	BK170
83020	SHARE M5/M7 18" R	BK170
83021	SHARE M5/M7 18" L	BK170
83022	SHARE M5/M7 20" R	BK170
83023	SHARE M5/M7 20" L	BK170
83010C	EUROCARBIDE M5/M7 point R	BK144
83011C	EUROCARBIDE M5/M7 point L	BK144
MOL83-0	M7 adapter R	BK175
MOL83-1	M7 adapter L	BK175
MOL83	M7 point rev. R&L	
4879058	Wedge for M7 point	
4879056	Wedge for M7 point	
73091	Share knife R	BK095
73092	Share knife L	BK095
53090	EUROPOINT Rev. R	BK094
63090	EUROPOINT Rev. L	BK094
5309MOLC	EUROCARBIDE point R	BK095
6309MOLC	EUROCARBIDE point L	BK095
73414	Bracket for 18" and 20" shares R	
73415	Bracket for 18" and 20" shares L	
83018C	EUROCARBIDE M5/M7 share 16" R	BK170
83019C	EUROCARBIDE M5/M7 share 16" L	BK170
83020C	EUROCARBIDE M5/M7 share 18" R	BK170
83021C	EUROCARBIDE M5/M7 share 18" L	BK170

## Landsides and share knives

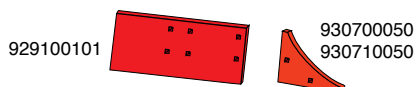

Article no.	Designation	BK. no.
929100101	Landside, long R&L	
930700050	Skim point R	BK095
930710050	Skim point L	BK095

Parts to fit:

# PÖTTINGER ploughbody 46W

## Mouldboards, shins and accessories

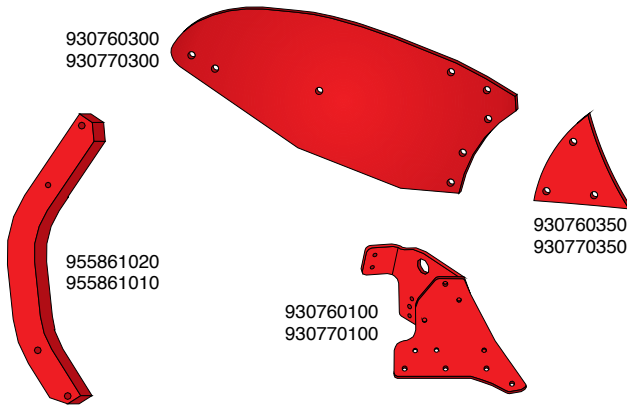

Article no.	Designation	BK. no.
930760300	Mouldboard R	
930770300	Mouldboard L	
930760350	Shin R	BK077
930770350	Shin L	BK077
930760100	Frog R	
930770100	Frog L	
955861020	Beam, R	
955861010	Beam, L	

## Shares, points and accessories

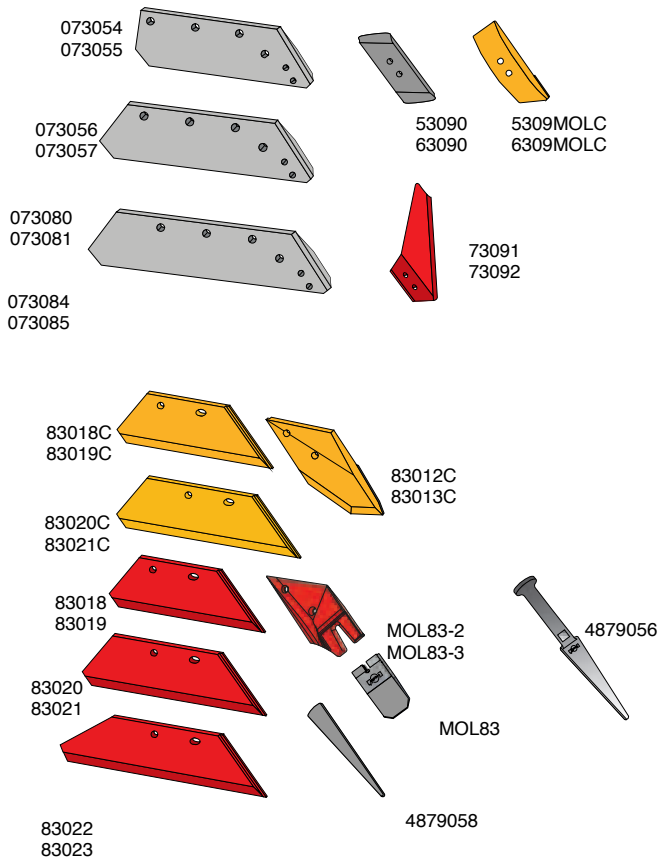

Article no.	Designation	BK. no.
073054	EUROSHARE 14" R	Bk113
073055	EUROSHARE 14" L	BK113
073056	EUROSHARE 16" R	BK113
073057	EUROSHARE 16" L	BK113
073080	EUROSHARE 18" R	BK113
073081	EUROSHARE 18" L	BK113
073084	EUROSHARE 20" R	BK113
073085	EUROSHARE 20" L	BK113
73091	Share knife R	BK095
73092	Share knife L	BK092
53090	EUROPOINT Rev. R	BK094
63090	EUROPOINT Rev. L	BK094
5309MOLC	EUROCARBIDE point R	BK095
6309MOLC	EUROCARBIDE point L	BK095
83018	SHARE M5/M7 16" R	BK170
83019	SHARE M5/M7 16" L	BK170
83020	SHARE M5/M7 18" R	BK170
83021	SHARE M5/M7 18" L	BK170
83022	SHARE M5/M7 20" R	BK170
83023	SHARE M5/M7 20" L	BK170
83012C	EUROCARBIDE M5 point R	BK111
83013C	EUROCARBIDE M5 point L	BK111
MOL83-2	M7 adapter R	BK175
MOL83-3	M7 adapter L	BK175
MOL83	M7 point rev. R&L	
4879058	Wedge for M7 point	
4879056	Wedge for M7 point	
83018C	EUROCARBIDE M5/M7 share 16" R	BK170
83019C	EUROCARBIDE M5/M7 share 16" L	BK170
83020C	EUROCARBIDE M5/M7 share 18" R	BK170
83021C	EUROCARBIDE M5/M7 share 18" L	BK170

## Landsides and share knives

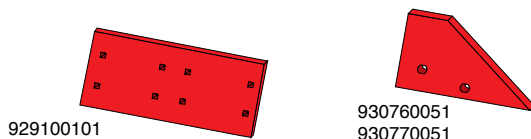

Article no.	Designation	BK. no.
929100101	Landside, long R&L	
930760051	Landside, front R	BK095
930770051	Landside, front L	BK095

Parts to fit:

# RABEWERK ploughbody BP-321, 322, 323 PS/PSL

## Mouldboards, shins and accessories

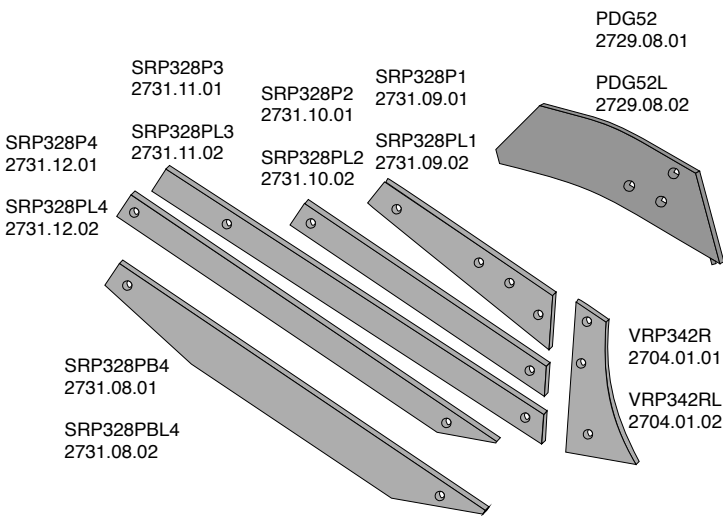

Article no.	Designation	BK. no.
PDG52	Trashboard R	BK077
PDG52L	Trashboard L	BK077
SRP328P1	Mouldboard stripe R	BK078
SRP328PL1	Mouldboard stripe L	BK078
SRP328P2	Mouldboard stripe R	BK069
SRP328PL2	Mouldboard stripe L	BK069
SRP328P3	Mouldboard stripe R	BK069
SRP328PL3	Mouldboard stripe L	BK069
SRP328P4	Mouldboard stripe R	BK069
SRP328PL4	Mouldboard stripe L	BK069
SRP327PB4	Mouldboard stripe R	BK069
SRP327PBL4	Mouldboard stripe L	BK069
VRP342R	Shin R (10 mm)	BK058
VRP342RL	Shin L (10 mm)	BK058

## Share and points

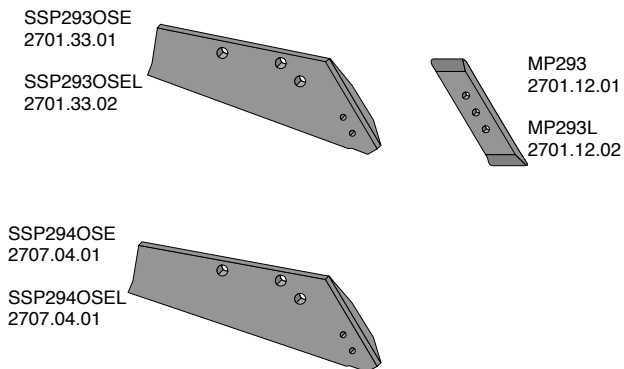

Article no.	Designation	BK. no.
Mp293	EUROPOINT, rev. R	BK094
MP293L	EUROPOINT, rev. L	BK094
SSP293OSE	EUROSHARE R	BK037
SSP293OSEL	EUROSHARE L	BK037
SSP294OSE	EUROSHARE R	BK037
SSP294OSEL	EUROSHARE L	BK037

## Landsides and share knives

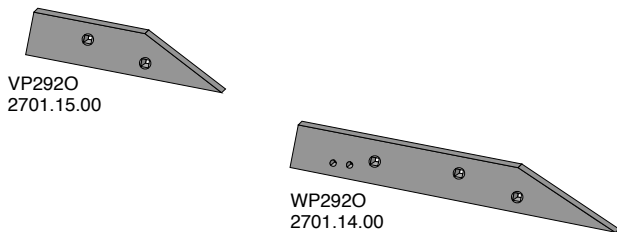

Article no.	Designation	BK. no.
VP292O	Landside, short R&L	BK033
WP292O	Landside, long R&L	BK040

## Parts to mount on landsides

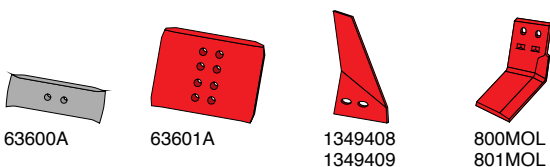

Article no.	Designation	BK. no.
63600A	Wearing plate, rev. R&L	BK094
63601A	Wearing plate, rev. R&L	BK094
1349408	Sword coulter R	BK052
1349409	Sword coulter L	BK052
800MOL	Subsoiler blade R	BK096
801MOL	Subsoiler blade L	BK096

Parts to fit:

# RABEWERK ploughbody BP-350 WS/WSL

## Mouldboards, shins and accessories

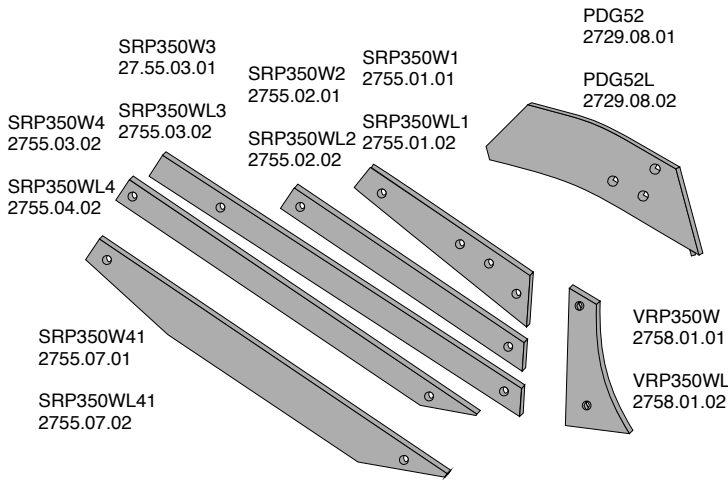

Article no.	Designation	BK. no.
PDG52	Trashboard R	BK077
PDG52L	Trashboard L	BK077
SRP350W1	Mouldboard stripe R	BK052
SRP350WL1	Mouldboard stripe L	BK052
SRP350W2	Mouldboard stripe R	BK052
SRP350WL2	Mouldboard stripe L	BK052
SRP350W3	Mouldboard stripe R	BK052
SRP350WL3	Mouldboard stripe L	BK052
SRP350W4	Mouldboard stripe R	BK052
SRP350WL4	Mouldboard stripe L	BK052
SRP350W41	Mouldboard stripe R	BK052
SRP350WL41	Mouldboard stripe L	BK052
VRP350W	Shin R (10 mm)	BK069
VRP350WL	Shin L (10 mm)	BK069

## Share and points

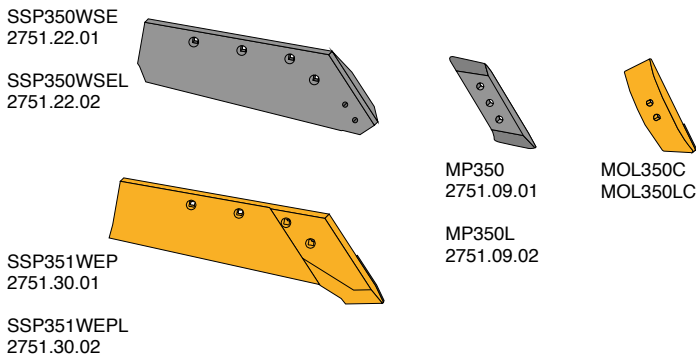

Article no.	Designation	BK. no.
Mp350	EUROPOINT, rev. R	BK094
MP350L	EUROPOINT, rev. L	BK094
MOL350C	EUROCARBIDE M3 point R	BK095
MOL350LC	EUROCARBIDE M3 point L	BK095
SSP350WSE	EUROSHARE R	BK038
SSP350WSEL	EUROSHARE L	BK038
SSP351WEP	EUROCARBIDE share R	BK038
SSP351WEPL	EUROCARBIDE share L	BK038

## Landsides and share knives

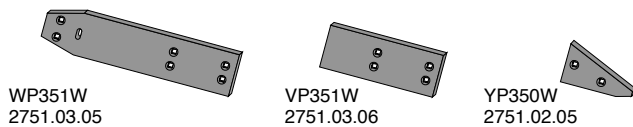

Article no.	Designation	BK. no.
WP351W	Landside, rev. R&L	BK042
VP351W	Landside, short, rev. R&L	BK042
YP350W	Skim point, rev. R&L	BK041

**Do you know...**  
 Mølbro uses 4000 tons of Boron steel  
 from Scandinavia – every year?



Parts to fit:

# RABEWERK ploughbody BP-2930, 2940L

## Mouldboards, shins and accessories

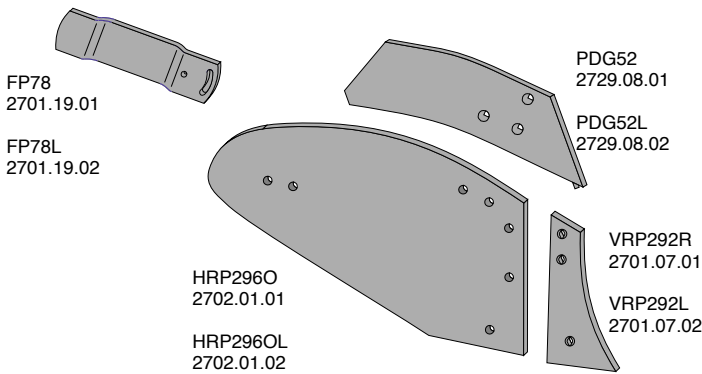

Article no.	Designation	BK. no.
PDG52	Trashboard R	BK077
PDG52L	Trashboard L	BK077
FP78	Mouldboard extension R	BK080
FP78L	Mouldboard extension L	BK080
HRP296O	Mouldboard R	BK081
HRP296OL	Mouldboard L	BK081
VRP292R	Shin R	BK058
VRP292L	Shin L	BK058

## Share and points

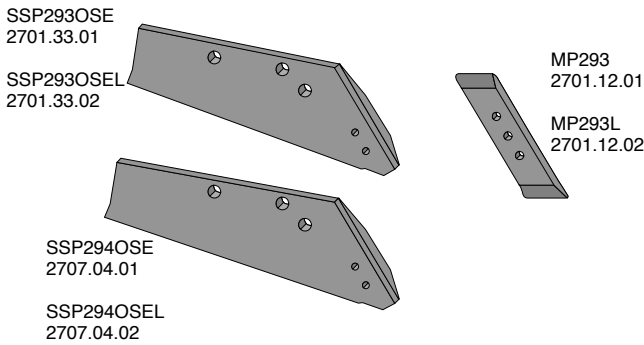

Article no.	Designation	BK. no.
MP293	EUROPOINT, rev. R	BK094
MP293L	EUROPOINT, rev. L	BK094
SSP293OSE	EUROSHARE R	BK037
SSP293OSEL	EUROSHARE L	BK037
SSP294OSE	EUROSHARE R	BK037
SSP294OSEL	EUROSHARE L	BK037

## Landsides and share knives

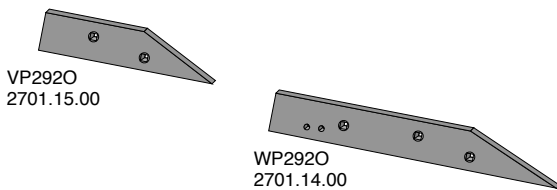

Article no.	Designation	BK. no.
VP292O	Landside, short R&L	BK033
WP292O	Landside, long R&L	BK040

## Parts to mount on landsides

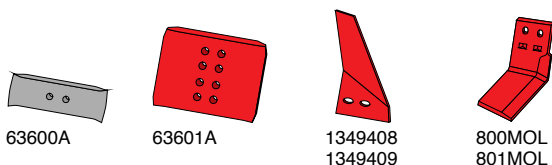

Article no.	Designation	BK. no.
63600A	Wearing plate, rev. R&L	BK094
63601A	Wearing plate, rev. R&L	BK094
1349408	Sword coulter R	BK052
1349409	Sword coulter L	BK052
800MOL	Subsoiler blade R	BK096
801MOL	Subsoiler blade L	BK096

Parts to fit:

# RABEWERK

## Share and points

SSP332OSE  
2708.27.02

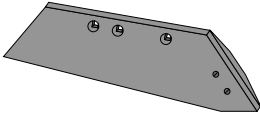

SSP332OSEL  
2708.27.02

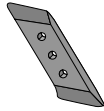

MP332  
2708.28.01

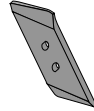

PK801101R  
PK801102L

SSP333OSE  
2753.15.01

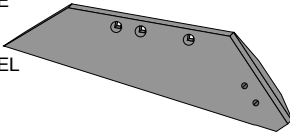

SSP333OSEL  
2753.15.02

MP332L  
2708.28.02

Article no.	Designation	BK. no.
SSP332OSE	EUROSHARE R	BK037
SSP332OSEL	EUROSHARE L	BK037
SSP333OSE	EUROSHARE R	BK037
SSP333OSEL	EUROSHARE L	BK037
SSP200JB	SHARE 14" R	BK037
SSP200JBL	SHARE 14" L	BK037
MP332	EUROPOINT rev. R	BK094
MP332L	EUROPOINT rev. L	BK094
PK801101R	EUROPOINT rev. R	BK094
PK801102L	EUROPOINT rev. L	BK094

SSP200JB  
2708.16.01

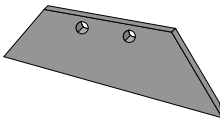

SSP200JBL  
2708.16.02

## Skim shares

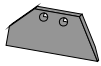

SDG14/16  
2742.02.01

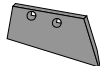

SDG181  
2715.01.01

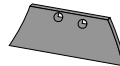

SDG18  
2715.05.01

SDG14/16L  
2742.02.02

SDG181L  
2715.01.02

SDG18L  
2715.05

Article no.	Designation	BK. no.
SDG14/16	Skim share R	BK003
SDG14/16L	Skim share L	BK003
SDG181	Skim share R	BK001
SDG181L	Skim share L	BK001
SDG18	Skim share R	BK001
SDG18L	Skim share L	BK001

## Disc coulters

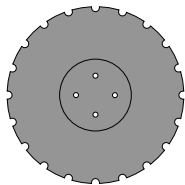

9031.13.29

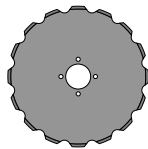

9022.52.11

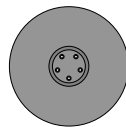

9008.55.10

Article no.	Designation
9031.13.29	Disc coulters, notched Ø445mm
9022.52.11	Disc coulters, notched Ø355mm
9008.55.10	Disc coulters, Ø300mm

**Do you know...**  
All Molbro's discs are produced in Boron steel.

Parts to fit:

# RABEWERK universal plough (LEMKEN)

## Mouldboards, shins and accessories

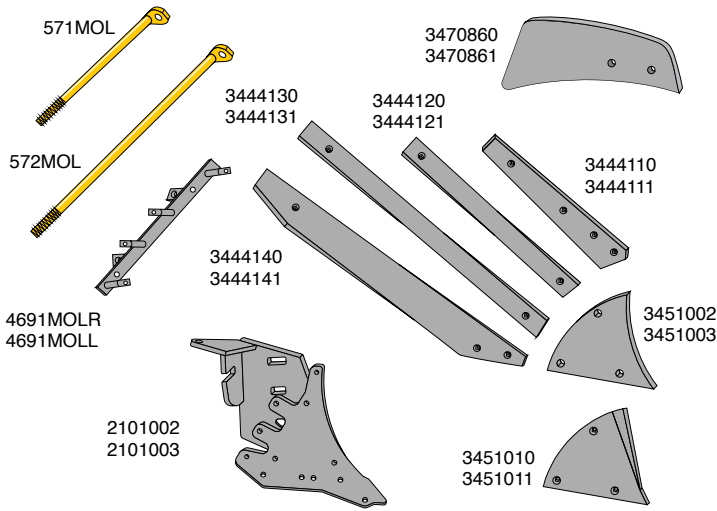

Article no.	Designation	BK. no.
3470860	Turbo-trashboard R	BK009
3470861	Turbo-trashboard L	BK009
4691MOLR	Stay with support R	
4691MOLL	Stay with support L	
571MOL	Support for stay, short	
572MOL	Support for stay, long	
3451002	Shin R (10mm)	BK007
3451003	Shin L (10mm)	BK007
3451010	Shin R (8mm)	BK010
3451011	Shin L (8mm)	BK010
3444110	Mouldboard stripe R	BK006
3444111	Mouldboard stripe L	BK006
3444120	Mouldboard stripe R	BK172
3444121	Mouldboard stripe L	BK172
3444130	Mouldboard stripe R	BK172
3444131	Mouldboard stripe L	BK172
3444140	Mouldboard stripe R	BK173
3444141	Mouldboard stripe L	BK173
2101002	Frog R	BK140
2101003	Frog L	BK140

## Share and points

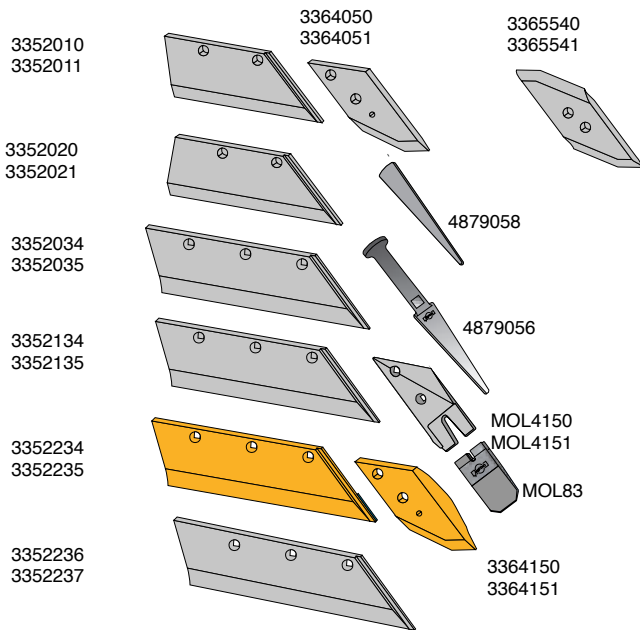

Article no.	Designation	BK. no.
3365540	EUROPOINT rev. R	BK032
3365541	EUROPOINT rev. L	BK032
3364050	EUROPOINT R	BK036
3364051	EUROPOINT L	BK036
3364150	EUROCARBIDE M5 point R	BK036
3364151	EUROCARBIDE M5 point L	BK036
3352010	SHARE M5 14" R	BK036
3352011	SHARE M5 14" L	BK036
3352020	SHARE M5 16" R	BK036
3352021	SHARE M5 16" L	BK036
3352034	SHARE M5 18" R	BK037
3352035	SHARE M5 18" L	BK037
3352134	SHARE M5 18" R (11mm)	BK037
3352135	SHARE M5 18" L (11mm)	BK037
3352234	EUROCARBIDE M5/M7 18" R	BK037
3352235	EUROCARBIDE M5/M7 18" L	BK037
3352236	EUROSHARE M5 18" R	BK037
3352237	EUROSHARE M5 18" L	BK037
MOL4150	M7 adapter R	BK036
MOL4151	M7 adapter L	BK036
MOL83	M7 point rev. R&L	
4879058	Wedge for M7 point	
4879056	Wedge for M7 point	

## Landsides and share knives

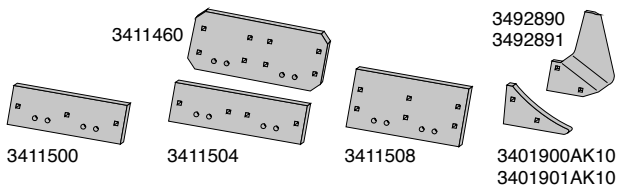

Article no.	Designation	BK. no.
3401900AK10	Landside, front R	BK008
3401901AK10	Landside, front L	BK008
3411500	Landside, short R&L	BK036
3411504	Landside, long R&L	BK036
3411508	Landside, tall R&L	BK037
3411460	Landside, tall R&L	BK037
3492890	Share knife R	BK003
3492891	Share knife L	BK003

## Parts to mount on landsides

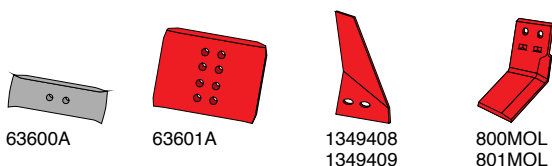

Article no.	Designation	BK. no.
63600A	Wearing plate, rev. R&L	BK094
63601A	Wearing plate, rev. R&L	BK094
1349408	Sword coulter R	BK052
1349409	Sword coulter L	BK052
800MOL	Subsoiler blade R	BK096
801MOL	Subsoiler blade L	BK096

Parts to fit:

# VOGEL & NOOT ploughbody UN400

## Mouldboard and shin

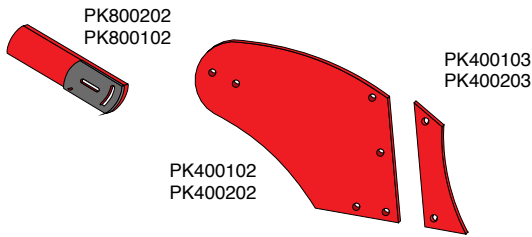

Article no.	Designation	BK. no.
PK400102	Mouldboard R	BK068
PK400202	Mouldboard L	BK068
PK400103	Shin R	BK021
PK400203	Shin L	BK021

## Skim

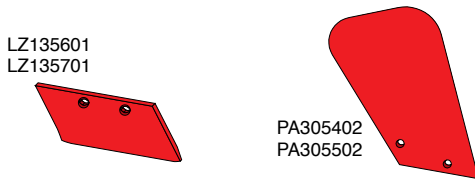

Article no.	Designation	BK. no.
LZ135601	Skim share R	BK069
LZ135701	Skim share L	BK069
PA305402	Skim mouldboard R	BK026
PA305502	Skim mouldboard L	BK026

## Share and points

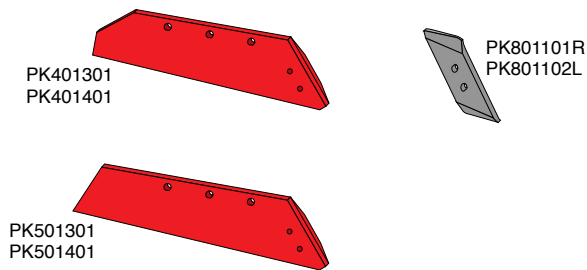

Article no.	Designation	BK. no.
PK401301	EUROSHARE 16" R	BK112
PK401401	EUROSHARE 16" L	BK112
PK501301	EUROSHARE 18" R	BK112
PK501401	EUROSHARE 18" L	BK112
PK801101R	EUROPOINT, rev. R	BK094
PK801102L	EUROPOINT, rev. L	BK094

## Landsides

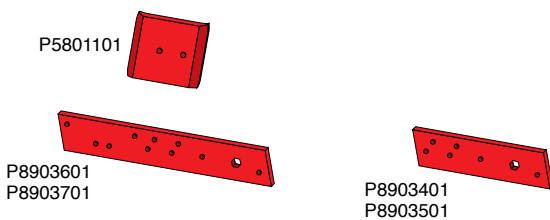

Article no.	Designation	BK. no.
P5801101	Wearing plate R&L	BK146
P8903401	Landside, short R	BK104
P8903501	Landside, short L	BK104
P8903601	Landside, long R	BK104
P8903701	Landside, long L	BK104

## Parts to mount on landsides

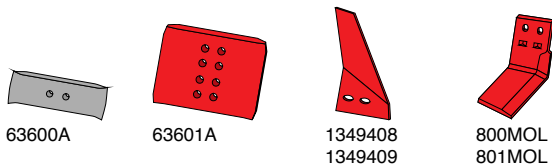

Article no.	Designation	BK. no.
63600A	Wearing plate, rev. R&L	BK094
63601A	Wearing plate, rev. R&L	BK094
1349408	Sword coulter R	BK052
1349409	Sword coulter L	BK052
800MOL	Subsoiler blade R	BK096
801MOL	Subsoiler blade L	BK096

Parts to fit:

# VOGEL & NOOT ploughbody WY 400

## Mouldboards, shins and accessories

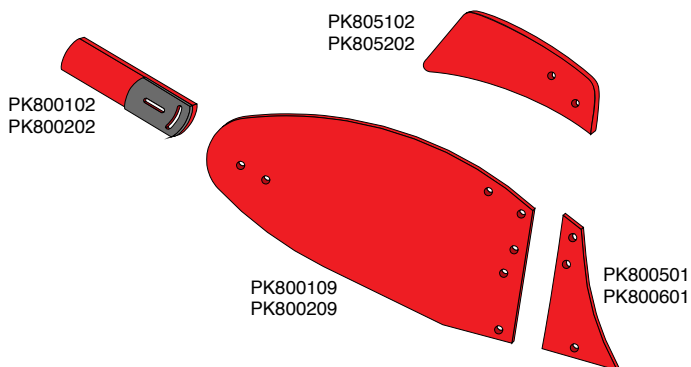

Article no.	Designation	BK. no.
PK800109	Mouldboard R	BK024
PK800209	Mouldboard L	BK024
PK800501	Shin R	BK022
PK800601	Shin L	BK022
PK805102	Turbo-trashboard R	BK167
PK805202	Turbo-trashboard L	BK167
PK800102	Mouldboard extension R	BK085
PK800202	Mouldboard extension L	BK085

## Share and points

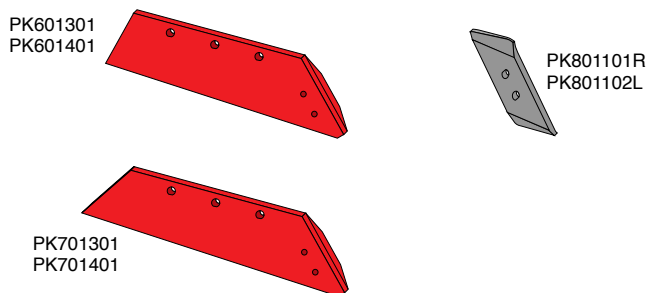

Article no.	Designation	BK. no.
PK601301	EUROSHARE 14" R	BK112
PK601401	EUROSHARE 14" L	BK112
PK701301	EUROSHARE 16" R	BK112
PK701401	EUROSHARE 16" L	BK112
PK801101R	EUROPOINT, rev. R	BK094
PK801102L	EUROPOINT, rev. L	BK094

## Landsides and share knives

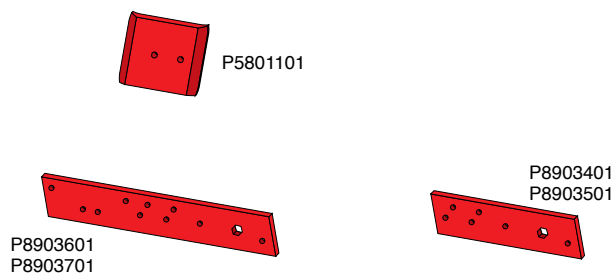

Article no.	Designation	BK. no.
P5801101	Wearing plate, rev. R&L	BK146
P8903401	Landside, short R	BK104
P8903501	Landside, short L	BK104
P8903601	Landside, long R	BK104
P8903701	Landside, long L	BK104

## Parts to mount on landsides

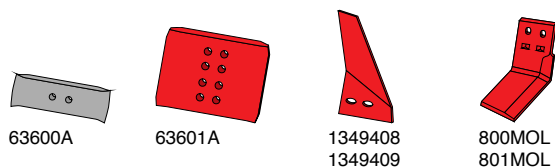

Article no.	Designation	BK. no.
63600A	Wearing plate, rev. R&L	BK094
63601A	Wearing plate, rev. R&L	BK094
1349408	Sword coulter R	BK052
1349409	Sword coulter L	BK052
800MOL	Subsoiler blade R	BK096
801MOL	Subsoiler blade L	BK096

Parts to fit:

# ÖVERUM SR ploughbody

## Mouldboards, shins and accessories

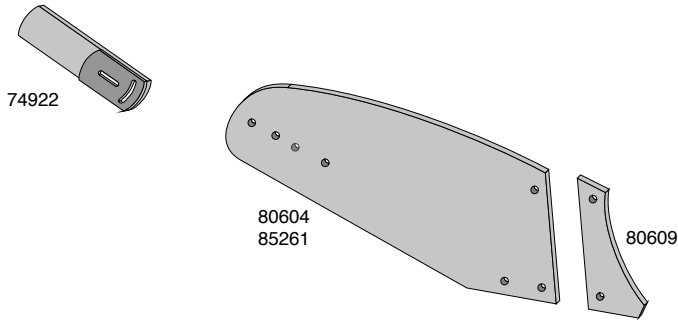

Article no.	Designation	BK. no.
80604/85261	Mouldboard R	BK060
74922	Mouldboard extension R	BK082
80609	Shin R	BK139

## Shares, points and accessories

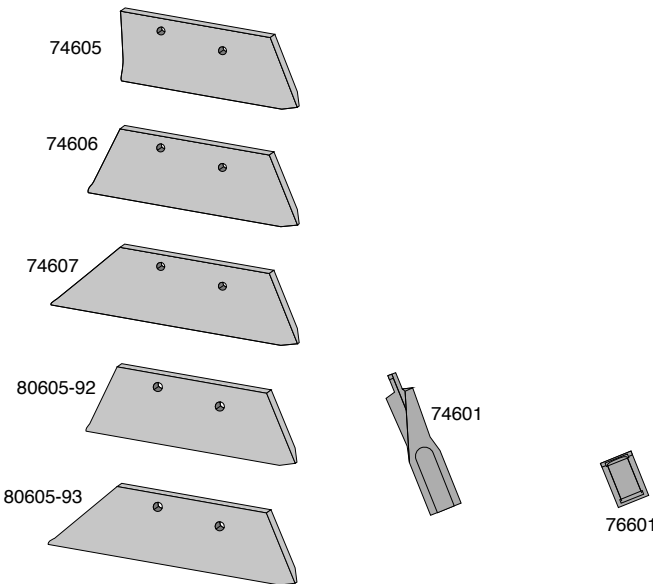

Article no.	Designation	BK. no.
74605	SHARE 12" R	BK119
74606	SHARE 14" R	BK119
74607	SHARE 16" R	BK119
80605-92	SHARE 14" R	BK050
80605-93	SHARE 16" R	BK050
74601	Point, steel casting R	
76601	Weldon point R	

## Landsides

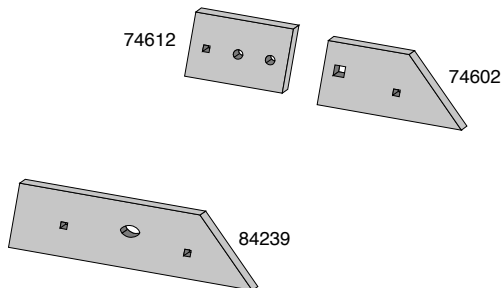

Article no.	Designation	BK. no.
84239	Landside, short R	BK138
74612	Wearing plate, rev. R	BK122
74602	Landside, front R	BK130

## Parts to mount on landsides

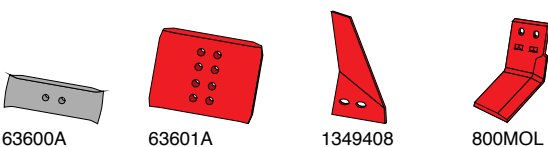

Article no.	Designation	BK. no.
63600A	Wearing plate, rev. R&L	BK094
63601A	Wearing plate, rev. R&L	BK094
1349408	Sword coulter R	BK052
800MOL	Subsoiler blade R	BK096



Parts to fit:

# ÖVERUM UC ploughbody

## Mouldboards, shins and accessories

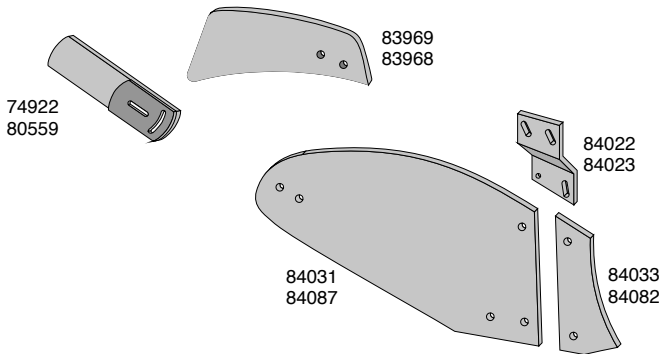

Article no.	Designation	BK. no.
83969	Turbotrashboard R	BK167
83968	Turbotrashboard L	BK167
84022	Fittings for trashboard R	
84023	Fittings for trashboard L	
74922	Mouldboard extension R	BK082
80559	Mouldboard extension L	BK082
84031	Mouldboard R	BK062
84087	Mouldboard L	BK062
84033	Shin R	BK065
84082	Shin L	BK065

## Shares, points and accessories

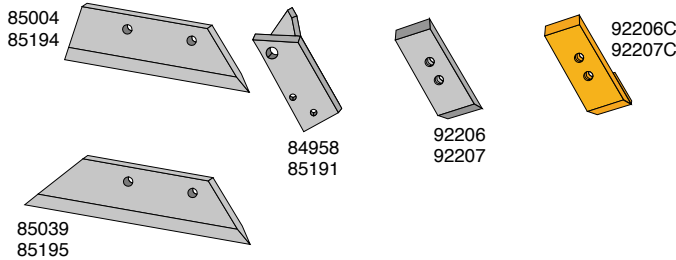

Article no.	Designation	BK. no.
92206	EUROPOINT, rev. R	BK087
92207	EUROPOINT, rev. L	BK087
92206C	EUROCARBIDE M3 point R	BK054
92207C	EUROCARBIDE M3 point L	BK054
84958	Support R	
85191	Support L	
85004	SHARE 16" R	BK052
85194	SHARE 16" L	BK052
85039	SHARE 18" R	BK052
85195	SHARE 18" L	BK052

## Landsides

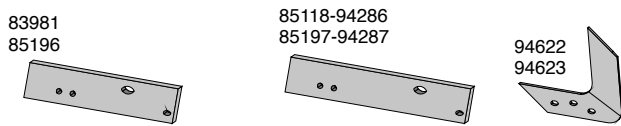

Article no.	Designation	BK. no.
83981	Landside, short R	BK074
85196	Landside, short L	BK074
85118-94286	Landside, long R	BK074
85197-94287	Landside, long L	BK074
94622	Share knife R	BK084
94623	Share knife L	BK084

## Parts to mount on landsides

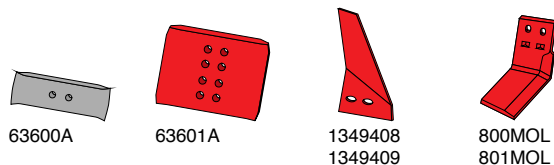

Article no.	Designation	BK. no.
63600A	Wearing plate, rev. R&L	BK094
63601A	Wearing plate, rev. R&L	BK094
1349408	Sword coulter R	BK052
1349409	Sword coulter L	BK052
800MOL	Subsoiler blade R	BK096
801MOL	Subsoiler blade L	BK096

### Do you know...

That the hard facing on the backside of Molbro's Eurocarbide points gives a self sharpening effect, so the point maintain the ability to attack the soil. Even when it is almost worn out.

Parts to fit:

# ÖVERUM V ploughbody

## Mouldboards, shins and accessories

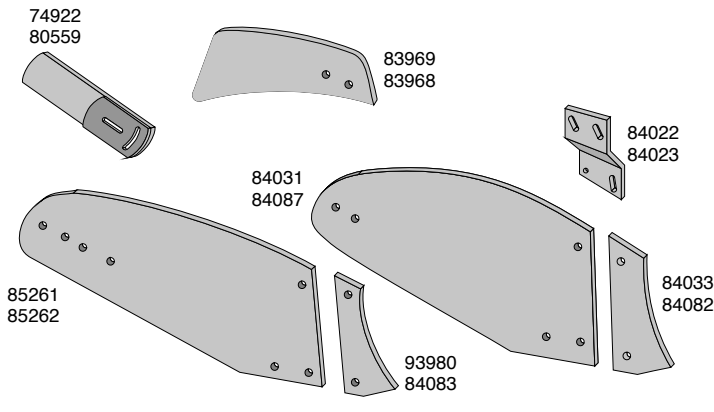

Article no.	Designation	BK. no.
83969	Turbo-trashboard R	BK167
83968	Turbo-trashboard L	BK167
84022	Fittings for trashboard R	
84023	Fittings for trashboard L	
74922	Mouldboard extension R	BK082
80559	Mouldboard extension L	BK082
84031	Mouldboard R	BK062
84087	Mouldboard L	BK062
84033	Shin R	BK065
84082	Shin L	BK065
85261	Mouldboard R	BK064
85262	Mouldboard L	BK064
83980	Shin R	BK065
84083	Shin L	BK065

## Shares, points and accessories

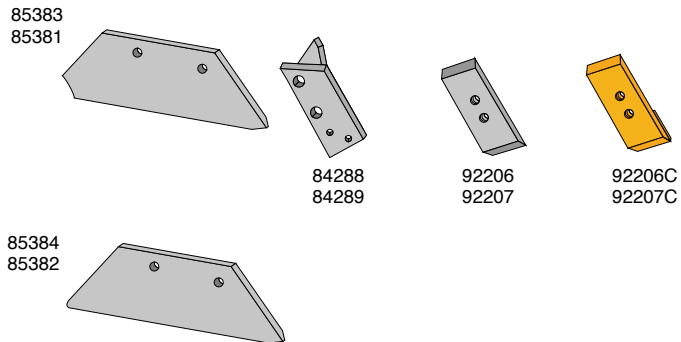

Article no.	Designation	BK. no.
92206	EUROPOINT, rev. R	BK069
92207	EUROPOINT, rev. L	BK069
92206C	EUROCARBIDE M3 point R	BK069
92207C	EUROCARBIDE M3 point L	BK069
84288	Support R	BK055
84289	Support L	BK055
85383	SHARE 16" R	BK052
85381	SHARE 16" L	BK052
85384	SHARE 18" R	BK052
85382	SHARE 18" L	BK052

## Landsides and share knives

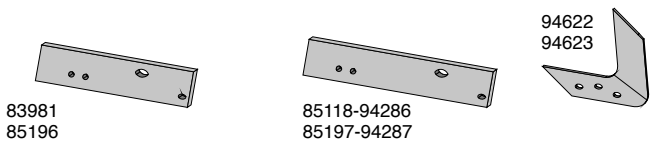

Article no.	Designation	BK. no.
83981	Landside, short R	BK074
85196	Landside, short L	BK074
85118-94286	Landside, long R	BK074
85197-94287	Landside, long L	BK074
94622	Share knife R	BK084
94623	Share knife L	BK084

## Parts to mount on landsides

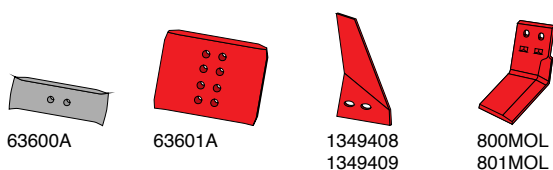

Article no.	Designation	BK. no.
63600A	Wearing plate, rev. R&L	BK094
63601A	Wearing plate, rev. R&L	BK094
1349408	Sword coulter R	BK052
1349409	Sword coulter L	BK052
800MOL	Subsoiler blade R	BK096
801MOL	Subsoiler blade L	BK096

Parts to fit:

# ÖVERUM XL ploughbody

## Mouldboards, shins and accessories

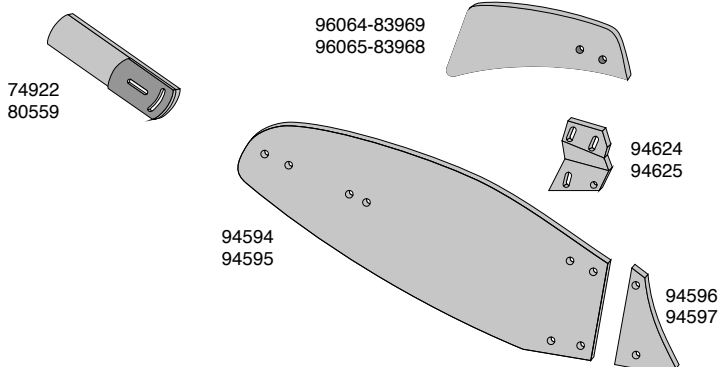

Article no.	Designation	BK. no.
96064-83969	Turbo-trashboard R	BK167
96065-83968	Turbo-trashboard L	BK167
94624	Fittings for trashboard R	BK082
94625	Fittings for trashboard L	BK082
74922	Mouldboard extension R	BK082
80559	Mouldboard extension L	BK082
94594	Mouldboard R	BK066
94595	Mouldboard L	BK066
94596	Shin R	BK052
94597	Shin L	BK052

## Shares, points and accessories

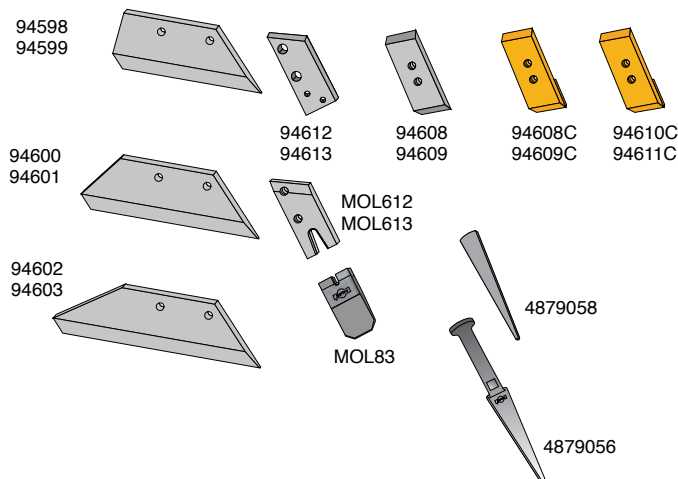

Article no.	Designation	BK. no.
94608	EUROPOINT, rev. R	BK086
94609	EUROPOINT, rev. L	BK086
94608C	EUROCARBIDE M3 point R	BK069
94609C	EUROCARBIDE M3 point L	BK069
94610C	EUROPOINT M5 R	
94611C	EUROPOINT M5 L	
94612	Support R	BK069
94613	Support L	BK069
MOL612	M7 adapter R	BK069
MOL613	M7 adapter L	BK069
MOL83	M7 point rev. R&L	
4879058	Wedge for M7 point	
4879056	Wedge for M7 point	
94598	M5/M7 SHARE 14" R	BK052
94599	M5/M7 SHARE 14" L	BK052
94600	M5/M7 SHARE 16" R	BK052
94601	M5/M7 SHARE 16" L	BK052
94602	M5/M7 SHARE 18" R	BK052
94603	M5/M7 SHARE 18" L	BK052

## Landsides and share knives

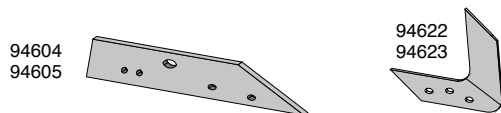

Article no.	Designation	BK. no.
94604	Landside R	BK074
94605	Landside L	BK074
94622	Share knife R	BK084
94623	Share knife L	BK084

## Parts to mount on landsides

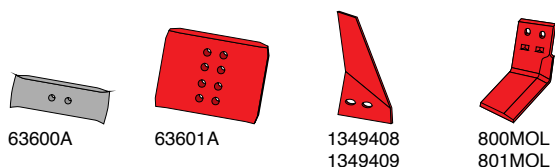

Article no.	Designation	BK. no.
63600A	Wearing plate, rev. R&L	BK094
63601A	Wearing plate, rev. R&L	BK094
1349408	Sword coulter R	BK052
1349409	Sword coulter L	BK052
800MOL	Subsoiler blade R	BK096
801MOL	Subsoiler blade L	BK096

Parts to fit:

# ÖVERUM XS ploughbody

## Mouldboards, shins and accessories

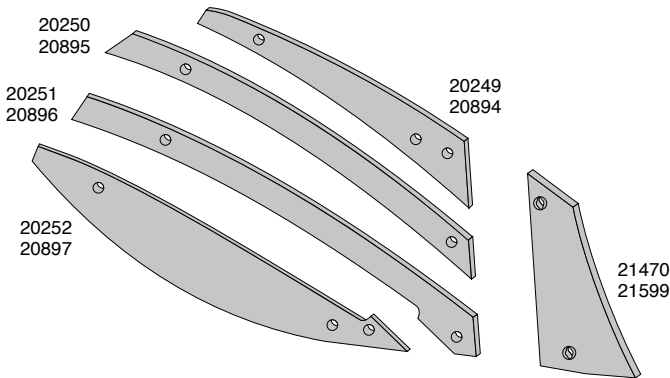

Article no.	Designation	BK. no.
20249	Mouldboard stripe R	BK058
20894	Mouldboard stripe L	BK058
20250	Mouldboard stripe R	BK052
20895	Mouldboard stripe L	BK052
20251	Mouldboard stripe R	BK052
20896	Mouldboard stripe L	BK052
20252	Mouldboard stripe R	BK058
20897	Mouldboard stripe L	BK058
21470	Shin R	BK052
21599	Shin L	BK052

## Shares, points and accessories

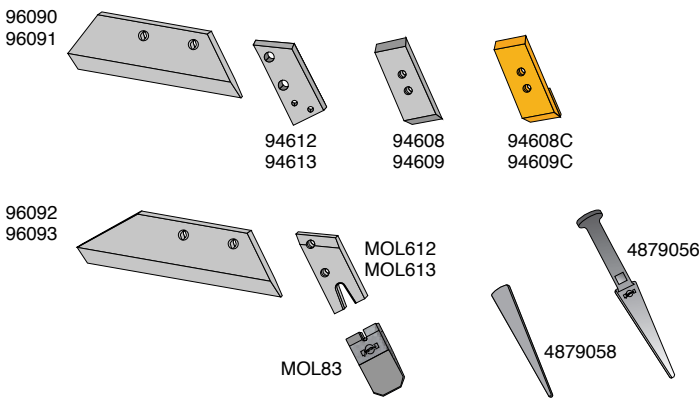

Article no.	Designation	BK. no.
94608	EUROPOINT, rev. R	BK086
94609	EUROPOINT, rev. L	BK086
94608C	EUROCARBIDE M3 point R	BK069
94609C	EUROCARBIDE M3 point L	BK069
94612	Support R	BK069
94613	Support L	BK069
96090	M7 SHARE 16" R	BK052
96091	M7 SHARE 16" L	BK052
96092	M7 SHARE 18" R	BK052
96093	M7 SHARE 18" L	BK052
MOL612	M7 adapter R	BK031
MOL613	M7 adapter L	BK031
MOL83	M7 point rev. R&L	
4879058	Wedge for M7 point	
4879056	Wedge for M7 point	

## Landsides and share knives

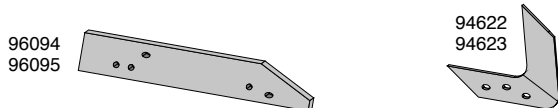

Article no.	Designation	BK. no.
96094	Landside R	BK069
96095	Landside L	BK069
94622	Share knife R	BK084
94623	Share knife L	BK084

## Parts to mount on landsides

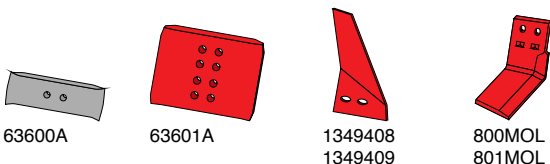

Article no.	Designation	BK. no.
63600A	Wearing plate, rev. R&L	BK094
63601A	Wearing plate, rev. R&L	BK094
1349408	Sword coulter R	BK052
1349409	Sword coulter L	BK052
800MOL	Subsoiler blade R	BK096
801MOL	Subsoiler blade L	BK096

Parts to fit:

# ÖVERUM XU ploughbody

## Mouldboards, shins and accessories

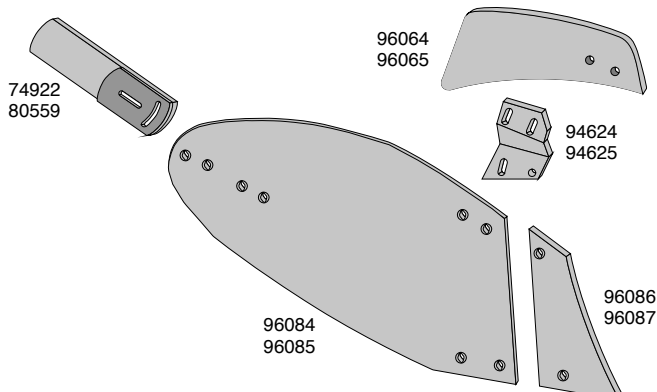

Article no.	Designation	BK. no.
96064	Turbo-trashboard R	BK167
96065	Turbo-trashboard L	BK167
94624	Fittings for trashboard R	BK082
94625	Fittings for trashboard L	BK082
74922	Mouldboard extension R	BK082
80559	Mouldboard extension L	BK082
96084	Mouldboard R	BK067
96085	Mouldboard L	BK067
96086	Shin R	BK052
96087	Shin L	BK052

## Shares, points and accessories

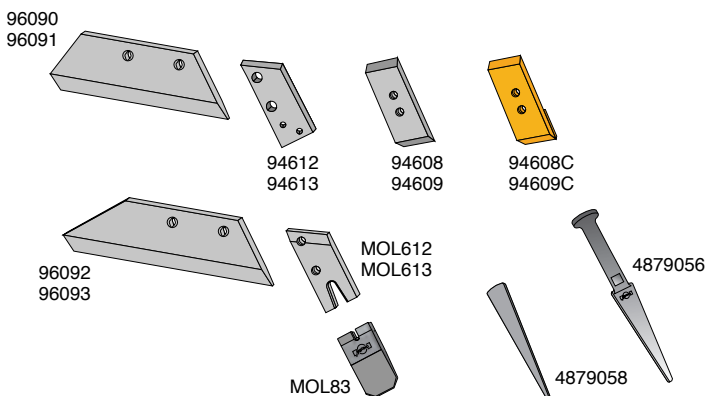

Article no.	Designation	BK. no.
94608	EUROPOINT, rev. R	Bk069
94609	EUROPOINT, rev. L	BK069
94608C	EUROCARBIDE M3 point R	BK069
94609C	EUROCARBIDE M3 point L	BK069
94612	Bracket plate R	BK069
94613	Bracket plate L	BK069
MOL612	M7 adapter R	BK031
MOL613	M7 adapter L	BK031
MOL83	M7 point rev. R&L	
4879058	Wegde for M7 point	
4879056	Wegde for M7 point	
96090	M7 SHARE 16" R	BK052
96091	M7 SHARE 16" L	BK052
96092	M7 SHARE 18" R	BK052
96093	M7 SHARE 18" L	BK052

## Landsides and share knives

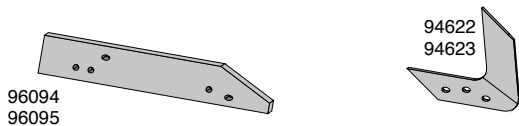

Article no.	Designation	BK. no.
96094	Landside R	BK069
96095	Landside L	BK069
94622	Share knife R	BK084
94623	Share knife L	BK084

## Parts to mount on landsides

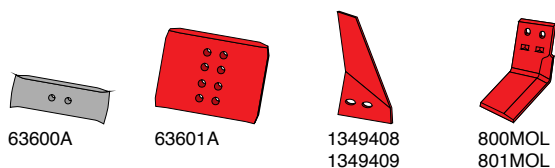

Article no.	Designation	BK. no.
63600A	Wearing plate, rev. R&L	63600A
63601A	Wearing plate, rev. R&L	63601A
1349408	Sword coulter R	1349408
1349409	Sword coulter L	1349409
800MOL	Subsoiler blade R	800MOL
801MOL	Subsoiler blade L	801MOL

Parts to fit:

# ÖVERUM XLD ploughbody

## Mouldboards and shins

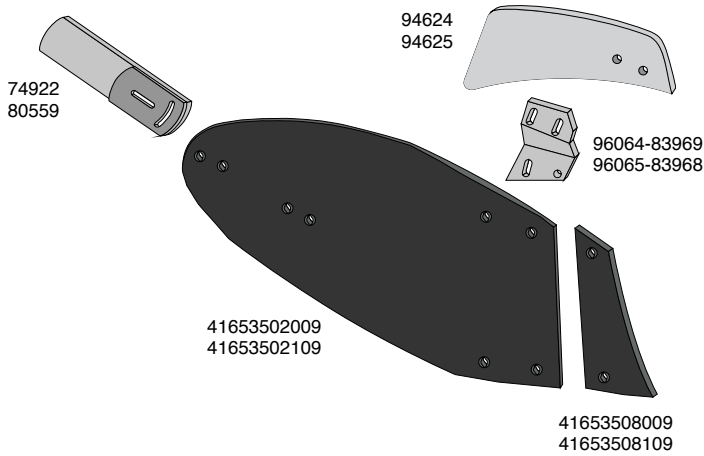

Artikel nr.	Betegnelse	BK.nr.
41653502009	Mouldboard R	
41653502109	Mouldboard L	
41653508009	Shin R	
41653508109	Shin L	
96064-83969	Turbo-trashboard R	BK167
96065-83968	Turbo-trashboard L	BK167
94624	Fittings for trashboard R	BK082
94625	Fittings for trashboard L	BK082
74922	Mouldboard extension R	BK082
80559	Mouldboard extension L	BK082

## Shares, points and accessories

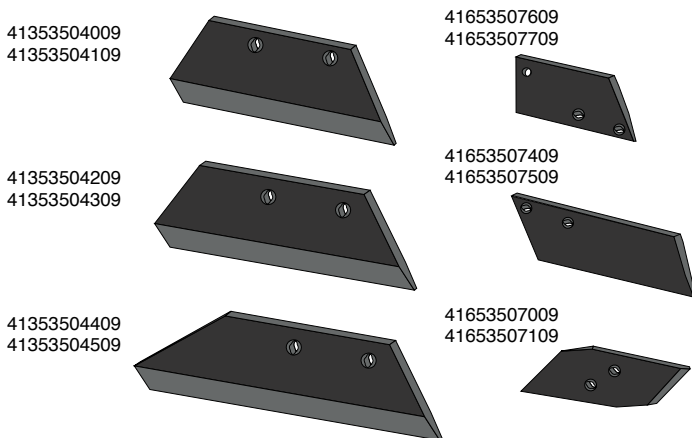

Artikel nr.	Betegnelse	BK.nr.
41653507009	EURO POINT R	
41653507109	EURO POINT L	
41653507409	EURO POINT rev. R	
41653507509	EURO POINT rev. L	
41653507609	Support for Point R	
41653507709	Support for Point L	
41353504009	EURO SHARE 16" R	
41353504109	EURO SHARE 16" L	
41353504209	EURO SHARE 18" R	
41353504309	EURO SHARE 18" L	
41353504409	EURO SHARE 20" R	
41353504509	EURO SHARE 20" L	

## Landsides and share knives

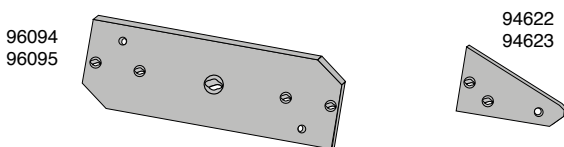

Artikel nr.	Betegnelse	BK.nr.
41653506209	Landside R	
41653506309	Landside L	
41653506009	Landside front R	
41653506109	Landside front L	

## Parts to mount on landsides and accessories

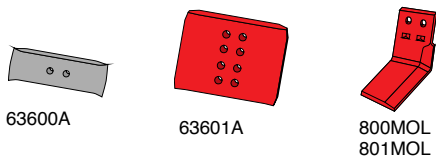

Artikel nr.	Betegnelse	BK.nr.
63600A	Wearing plate, rev. R&L	BK094
63601A	Wearing plate, rev. R&L	BK094
	Sword coulter R	
	Sword coulter L	
800MOL	Subsoiler blade R	BK096
801MOL	Subsoiler blade L	BK096



Parts to fit:

# ÖVERUM

## Skim shares and skim mouldboards

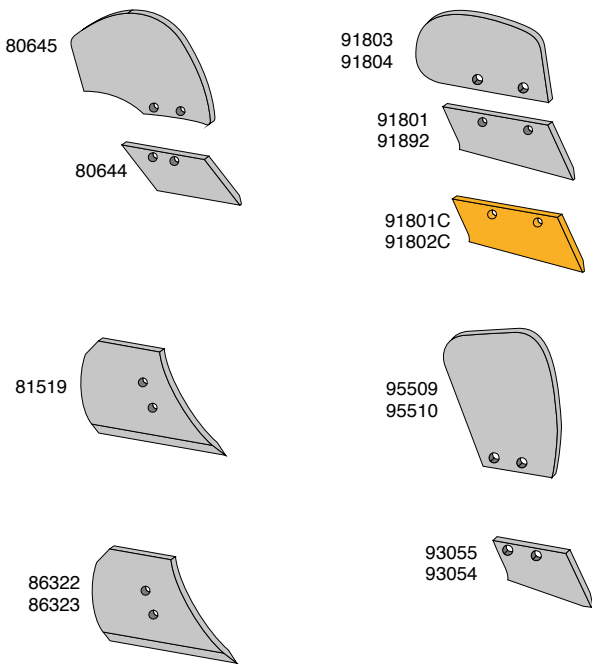

Article no.	Designation	BK. no.
80645	Skim mouldboard R	BK003
91803	Skim mouldboard R	BK052
91804	Skim mouldboard L	BK052
95509	Skim mouldboard H	BK052
95510	Skim mouldboard L	BK052
81519	Skim share R	BK008
86322	Skim share R	BK001
86323	Skim share L	BK001
80644	Skim share H	BK050
91801	Skim share H	BK052
91802	Skim share L	BK052
91801C	EUROCARBIDE Skim share H	BK052
91802C	EUROCARBIDE Skim share L	BK052
93055	Skim share H	BK052
93054	Skim share L	BK052

## Disc coulters and accessories

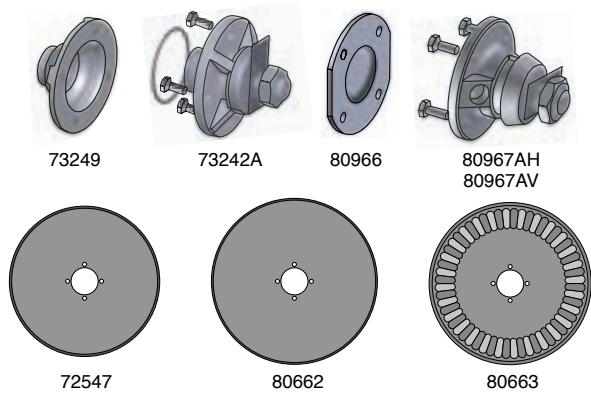

Article no.	Designation
73249	Cover for disc coulters R&L
80966	Cover for disc coulters R&L
73242A	Hub disc coulters R&L
80967AH	Hub disc coulters M30 R
80967AV	Hub disc coulters M30 L
72547	Disc coulters 18" R&L
80662	Disc coulters 20" R&L
80663	Disc coulters, rippled 20" R&L

Parts to fit:

# ÖVERUM SM, SML and SMK ploughbody

## Share and points

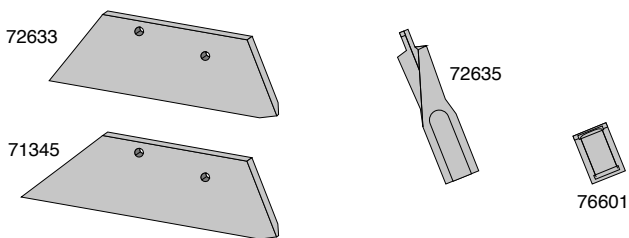

Article no.	Designation	BK. no.
72633	Share 14" R	BK122
71345	Share 16" R	BK122
76601	Weldon point R	
72635	Point, steel casting R	



# Subsoiler & Harrow



Parts to fit:

## KVERNELAND subsoiler "S" model AGROMAT

### Wings and points

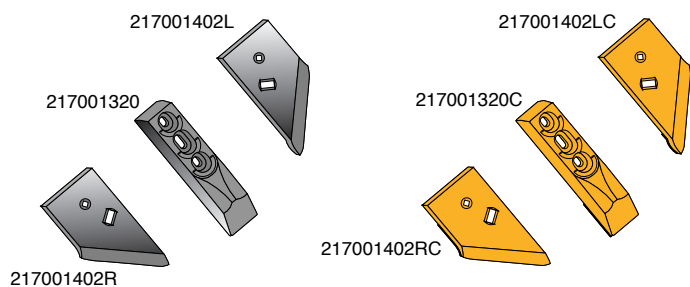

Article no.	Designation	BK. no.
217001320	Rev. point	
217001320C	EUROCARBIDE point	
217001402R	Wing R, wide	BK044
217001402L	Wing L, wide	BK044
217001402RC	Wing R, carbide coated	BK044
217001402LC	Wing L, carbide coated	BK044

Parts to fit:

## KVERNELAND Bonator subsoiler

### Wings and points

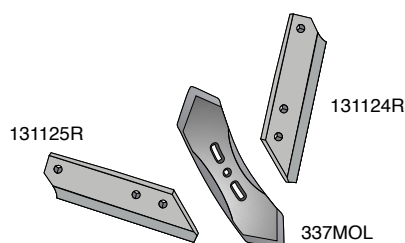

Article no.	Designation	BK. no.
131124R	Wing R	BK099
131125R	Wing L	BK099
337MOL	Rev. point 12 x 120 x 455mm	BK034

Parts to fit:

## Standard subsoiler and harrows

### Shares, points and accessories

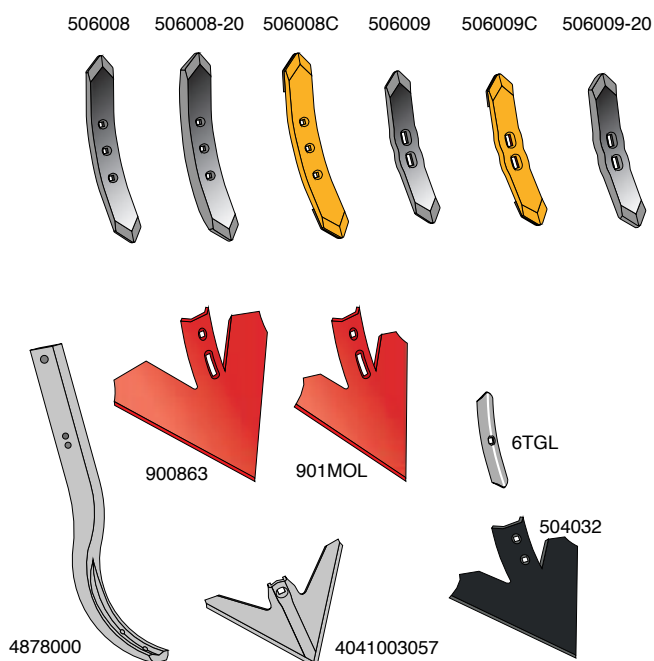

Article no.	Designation	BK. no.
506008	Rev. point, 16 x 60 x 495mm	BK046
506008-20	Rev. point, 20 x 60 x 495mm	BK046
506008C	EUROCARBIDE point rev, 16 x 60 x 495mm	BK046
506009	Rev. point, 15 x 55 x 410mm	BK046
506009C	EUROCARBIDE point rev, 15 x 55 x 410mm	BK046
506009-20	Rev. point, 13 x 55 x 410mm	BK046
900863	Duck foot point, 460mm	BK047
901MOL	Duck foot point, 310mm	BK047
6TGL	EUROPOINT, rev. 6 x 40 x 210mm	BK160
4041003057	Duck foot point, 252mm	
4878000	Universal beam	
504032	Duck foot point 205 x 197 x 6mm	

Parts to fit:

## Standard subsoiler and harrows

### Wings and points

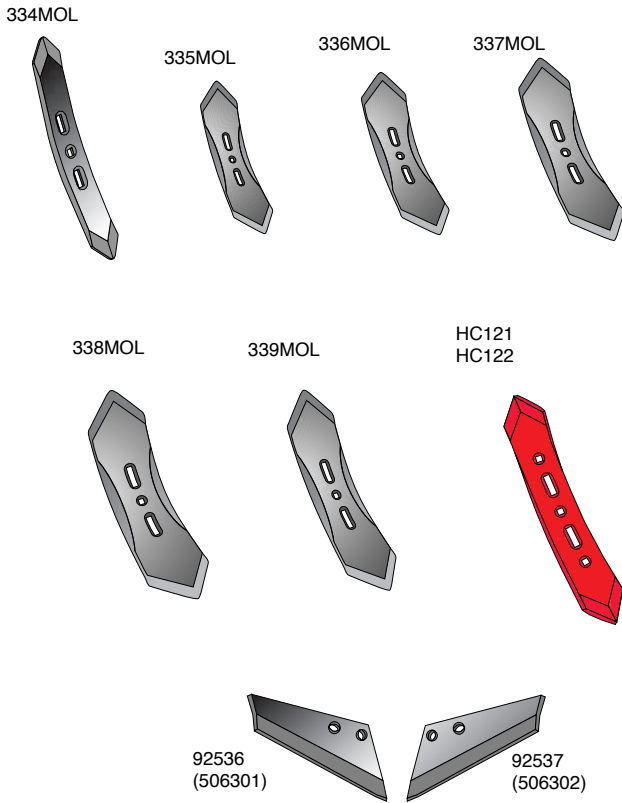

Article no.	Designation	BK. no.
334MOL	Rev. point, 16 x 60 x 490	BK034
335MOL	Rev. point, Rev. point,	BK034
336MOL	Rev. point, 12 x 100 x 420	BK034
337MOL	Rev. point, 10 x 120 x 455	BK034
338MOL	Rev. point, 10 x 130 x 485	BK034
339MOL	Rev. point, 12 x 100 x 480	BK034
HC121 HC122	Point turned R 80 x 12 x 510	
	Point turned L 80 x 12 x 510	
92536 (506301)	Wing R, 8mm	BK021
92537 (506302)	Wing L, 8mm	BK021

Parts to fit:

## USA standard subsoiler, CASE, NEW HOLLAND

### Shares, points and accessories



Article no.	Designation
NN101582 (33310060)	Wing point, standard 330 x 190 x 30mm
NN10685	Point, standard 330 x 30mm
BN90989	Point 50 x 8mm
C NELSON	Duck foot point, 200mm

Parts to fit:

# Standard Disc, KVERNELAND, HORSCH, FORTSCHRITT

## Disc

Article no. 331354271  
 Designation Disc, notched, Ø 660x6 mm fits to: Fortschritt

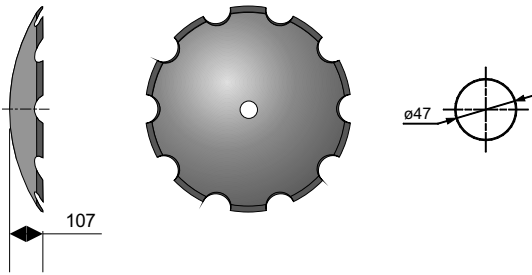

MDU1-660 Disc, notched, Ø 660x6 mm fits to: Kuhn 117109 Väderstad 406938 (Ø42) Vogel & Noot DSQ06609 (Ø41)

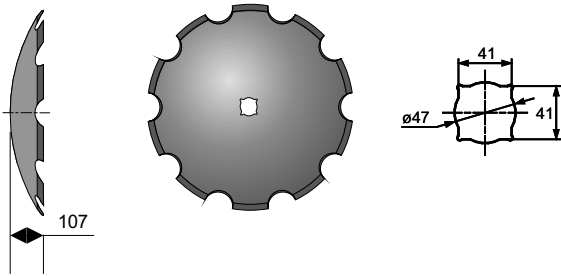

MDU3-660-6 Disc, notched, Ø 660x6 mm fits to: Dalbo 72387 (41x41) Rabe 64423202 (30x30) Kverneland KK121220R (40x40)

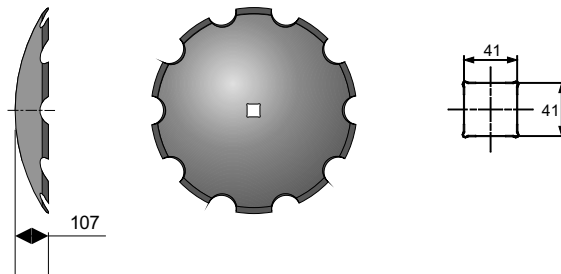

MDU3-660-8 Disc, notched, Ø 660x8 mm fits to: Dalbo 72387 (41x41) Rabe 64423202 (30x30) Kverneland KK121220R (40x40)

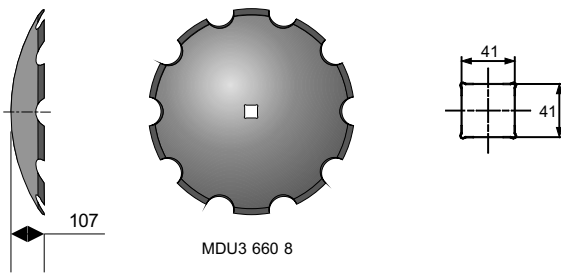

MDU4-660-6 Disc, notched, Ø 660x6 mm fits to: Dalbo 72387 (41x41) Rabe 64423202 (30x30) Kverneland KK121220R (40x40)

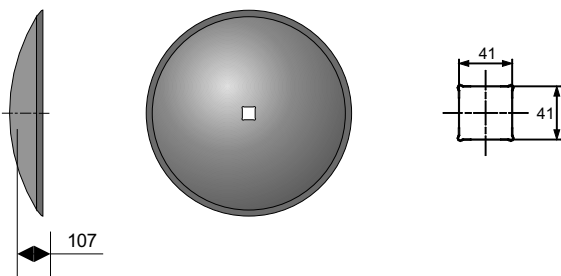

MDU4-660-8 Disc, notched, Ø 660x8 mm fits to: Dalbo 72387 (41x41) Rabe 64423202 (30x30) Kverneland KK121220R (40x40)

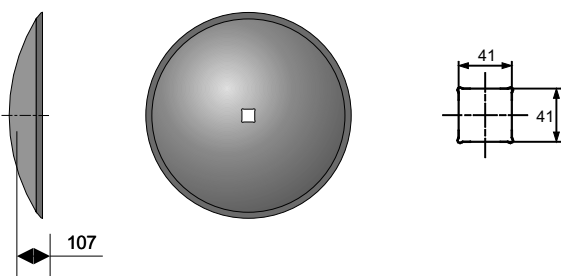

Parts to fit:

# Standard Disc, KVERNELAND, HORSCH, FORTSCHRITT

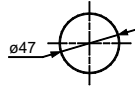
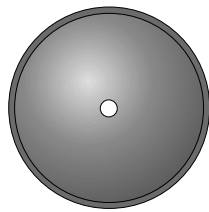
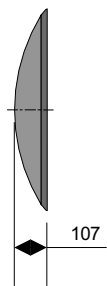

Article no.  
MDU5-660-6

Designation  
Disc, Ø 660x6 mm fits to: Kuhn  
117109 Väderstad 406938 (Ø42)  
Vogel & Noot DSQ06609 (Ø41)

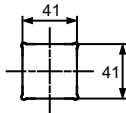
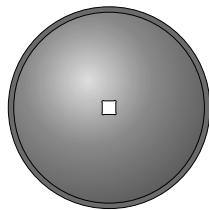
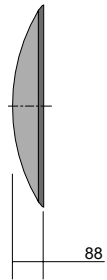

MDU4-610-6 Disc, Ø 610x6 mm

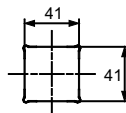
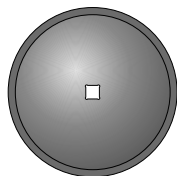
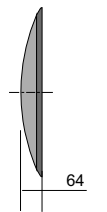

MDU4-510-6 Disc, Ø 510x6 mm fits to: Dalbo  
72388 (41x41)

















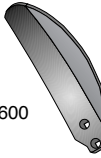
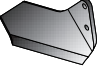

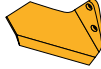

*If you have special requirements to hole-shape in Mølbro's discs please contact us for details.*

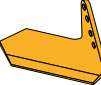

Parts to fit:

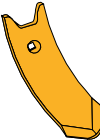
# HORSCH subsoiler

## Guide boards, wings and points

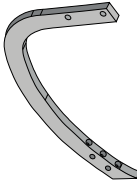
	Article no.	Designation	BK. no.
	34060858		
	34060859		
	34060862		
	34060863		
	34060859	Guideboard R	BK147
	34060858	Guideboard L	BK147
	34060863	Guideboard R	BK147
	34060862	Guideboard L	BK147
	34182600	Side guideboard L	BK147
	34182600		
	34182700		
	34182700	Side guideboard R	BK147
	3400857		
	34060856		
	34060857C		
	34060856C		
	34060857	Wing R	
	34060854	Wing L	
	34060857	Wing R	
	34060856	Wing L	
	00311328		
	00311329		
	34060857C	EUROCARBIDE Wing R	
	34060856C	EUROCARBIDE Wing L	
	00311328C		
	00311329C		
	00311328	Wing, 4 holes, L	
	00311329	Wing, 4 holes, R	
	00311328C	EUROCARBIDE, Wing, 4 holes, L	
	00311329C	EUROCARBIDE, Wing, 4 holes, R	
	34060850		
	34060850-15		
	00310915		
	34060850	EUROPOINT 80x12mm	BK148
	34060850-15	EUROPOINT 80x15mm	BK148
	00310915	EUROPOINT 80x15mm	BK148
	34060850C	EUROCARBIDE point 80x12mm	BK148
	34060850C		
	3460850C-15		
	00310915C		
	34060850C-15	EUROCARBIDE point 80x15mm	BK148
	00310915C	EUROCARBIDE point 80x15mm	BK148
	MLB00310969-2	EUROPOINT with tiles 2 holes 80x20mm	BK177
	MLB00311069-2		
	34060836		
	34060836	Beam	

Parts to fit:

# HORSCH subsoiler

## Points

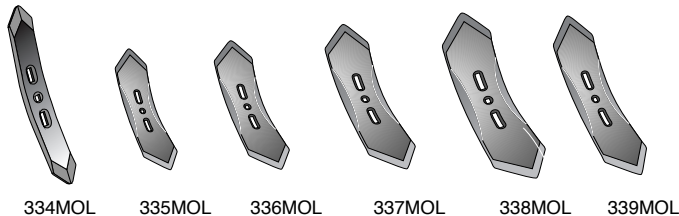

Article no.	Designation	BK. no.
334MOL	Rev. point, 16 x 60 x 490mm	BK034
335MOL	Rev. Point, 12 x 80 x 420mm	BK034
336MOL	Rev. Point, 12 x 100 x 420mm	BK034
337MOL	Rev. Point, 12 x 100 x 420mm	BK034
338MOL	Rev. Point, 10 x 130 x 485mm	BK034
339MOL	Rev. Point, 12 x 100 x 480mm	BK034

## Disc coulters

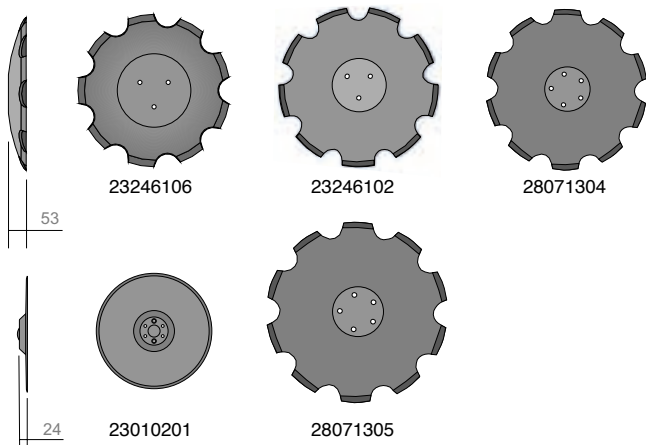

Article no.	Designation
23246106	Disc coulters, concave, notched Ø455mm
23246102	Disc coulters, concave, notched Ø460mm
28071304	Disc coulters, concave, notched Ø460mm
23010201	Disc coulters, flat, Ø340 mm
28071305	Disc coulters, concave, notched Ø520mm

Parts to fit:

# BOURGAULT subsoiler

## Points

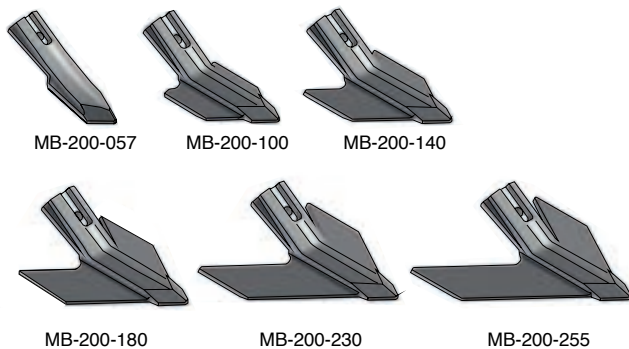

Article no.	Designation
MB-200-057	Point, 57mm
MB-200-100	Point, 100mm
MB-200-140	Point, 140mm
MB-200-180	Point, 180mm
MB-200-230	Point, 230mm
MB-200-255	Point, 255mm



**EUROCARBID**  
**Parts for subsoilers**



Parts to fit:

# KÖCKERLING subsoiler and standard subsoiler

## Guide boards, wings and points

Article no.	Designation	BK. no.
907020	Guideboard center, with safety catch	BK148
907024	Guideboard R	BK148
907026	Guideboard L	BK148
506000	Guideboard R	BK148
506001	Guideboard L	BK148
506046	Guideboard center	BK148
506014	EUROPOINT, 12 x 100 x 288mm	BK148
506014C	EUROCARBIDE point, 12 x 100 x 288mm	BK148
506064	EUROPOINT, 12 x 80 x 288mm	BK148
506064C	EUROPOINT, 14 x 80 x 288mm	BK148
506065	EUROCARBIDE point, 14 x 80 x 288mm	BK148
506065C	EUROCARBIDE point, 14 x 80 x 288mm	BK148
506025	Wing, 350mm	
506025C	EUROCARBIDE wing, 350mm	
664430	Wing, 350mm	
506008	EUROPOINT, rev, 16 x 60 x 495mm	BK046
506008C	EUROCARBIDE point rev, 16 x 60 x 495mm	BK046
506008-20	EUROPOINT, rev, 20 x 60 x 495mm	BK046
506009	EUROPOINT, rev, 15 x 55 x 410mm	BK046
506009C	EUROCARBIDE point rev, 16 x 60 x 495mm	BK046
506009-20	EUROPOINT, rev, 20 x 55 x 410mm	BK046
900863	Duck foot point, 460mm	BK047
901MOL	Duck foot point, 310mm	BK047
504032	Duck foot point, 205 x 197 x 6mm	
506009-20		
MLB915776	EUROPOINT with tiles 80x20mm	BK177

**Do you know...**  
 That Molbro produces guideboards for Köckerling with open bracket? This way you do not have to demount the point to change the guideboard.

Parts to fit:

## LEMKEN Smaragd / Topas subsoiler

### Guide boards and points

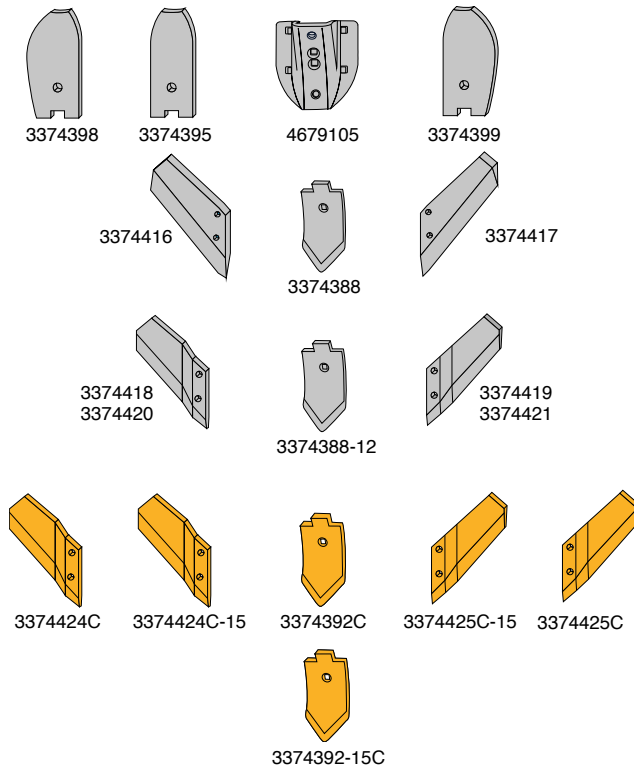

Article no.	Designation	BK. no.
4679105	Foot Stein 10	BK048
3374398	Guide board outer R	BK049
3374395	Guide board center	BK049
3374399	Guide board outer L	BK049
3374416	Wing 10 mm R	BK088
3374417	Wing 10 mm L	BK088
3374418	Wing, Curved 10 mm R	BK088
3374419	Wing, Curved 10 mm L	BK088
3374420	Wing, Curved 11 mm R	BK088
3374421	Wing, Curved 11 mm L	BK088
3374424C-15	Wing, Curved, carbide R	BK088
3374425C-15	Wing, Curved, carbide L	BK088
3374424C	Wing, Curved, carbide R	BK088
3374425C	Wing, Curved, carbide L	BK088
3374388	EUROPOINT 120x10 mm	BK035
3374388-12	EUROPOINT 120x12 mm	BK035
3374392C	EUROCARBIDE point 120x12mm	BK035
3374392-15C	EUROCARBIDE point 120x15mm	BK035

Parts to fit:

## LEMKEN Thorit / Achat subsoiler

### Guide boards and points

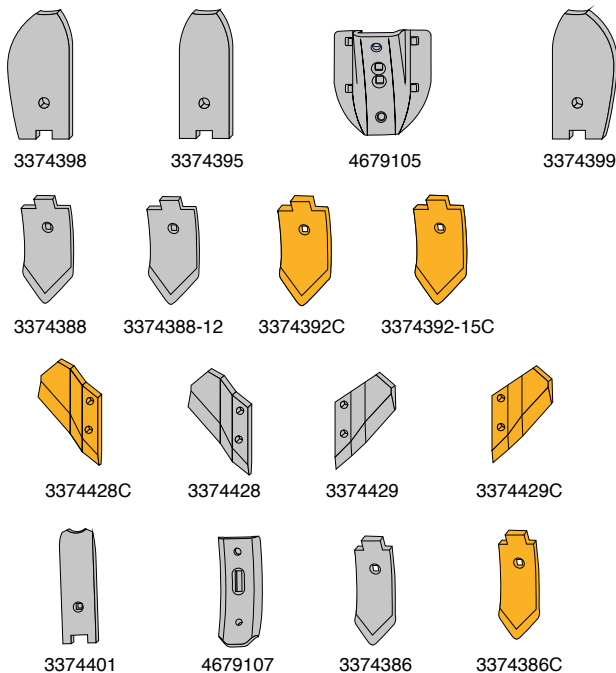

Article no.	Designation	BK. no.
3374398	Guide board outer R	BK049
3374395	Guide board center	BK049
4679105	Guide board center	BK048
3374399	Guide board outer L	BK049
3374388	EUROPOINT 120x10mm	BK035
3374388-12	EUROPOINT 120x12mm	BK035
3374392C	EUROCARBIDE point 120x12mm	BK035
3374392-15C	EUROCARBIDE point 120x15mm	BK035
3374428C	Wing, Curved, carbide R	BK088
3374428	Wing, Curved, R	BK088
3374429	Wing, Curved, L	BK088
3374429C	Wing, Curved, carbide L	BK088
3374401	Guide board center	BK049
4679107	Foot	BK048
3374386	EUROPOINT 80x12mm	BK035
3374386C	EUROCARBIDE point 80x12mm	BK035

Parts to fit:

## LEMKEN Kristall / Karat subsoiler

### Guide boards, wings and points

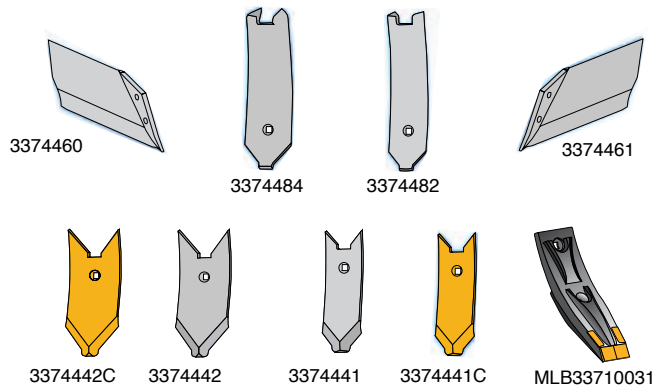

Article no.	Designation	BK. no.
3374460	Wing R	
3374461	Wing L	
3374484	Guideboard center 100x8mm	BK174
3374482	Guideboard center 80x8mm	BK174
3374442	EUROPOINT 120x10mm	BK174
3374441	EUROPOINT 80x14mm	BK174
3374442C	EUROCARBIDE point 120x12mm	BK174
3374441C	EUROCARBIDE point 80x14mm	BK174
MLB33710031	EUROPOINT with tiles	

Parts to fit:

## LEMKEN subsoiler

### Ponits and Disc coulters

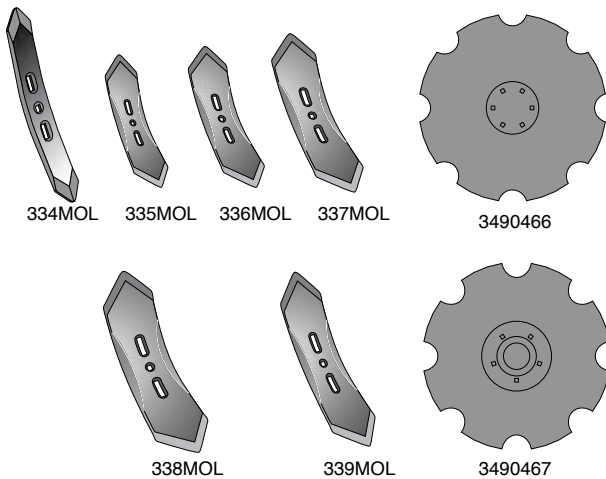

Article no.	Designation	BK. no.
334MOL	Rev. Point, 16 x 60 x 490mm	BK034
335MOL	Rev. point, 12 x 80 x 420mm	BK034
336MOL	Rev. Point, 12 x 100 x 420mm	BK034
337MOL	Rev. point, 10 x 120 x 455mm	BK034
338MOL	Rev. point, 10 x 130 x 485mm	BK034
339MOL	Rev. point, 12 x 100 x 480mm	BK034
3490466	Disc coulter, concave, notched Ø625mm	
3490467	Disc coulter, concave, notched Ø625mm	

Parts to fit:

## LEMKEN-KOMPAKTOR

### Point

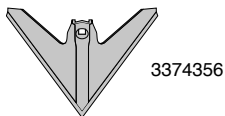

Article no.	Designation	BK. no.
3374356	Duck foot point 250 x 5mm	BK017

Parts to fit:

## LEMKEN seeder

### Seeding

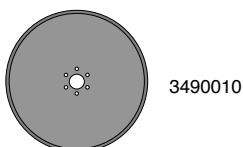

Article no.	Designation
3490010	Seeding Disc, flat Ø350mm



Parts to fit:

# VÄDERSTAD seeder

## Fertilizing

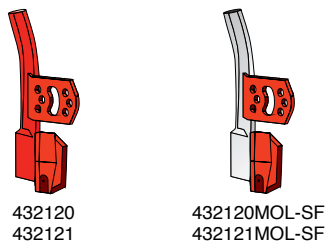

Article no.	Designation
432120	Seed share, fertilizer L
432121	Seed share, fertilizer R
432120MOL-SF	Seed share, fertilizer L
432121MOL-SF	Seed share, fertilizer R

## Seeding, disc coulters and accessories

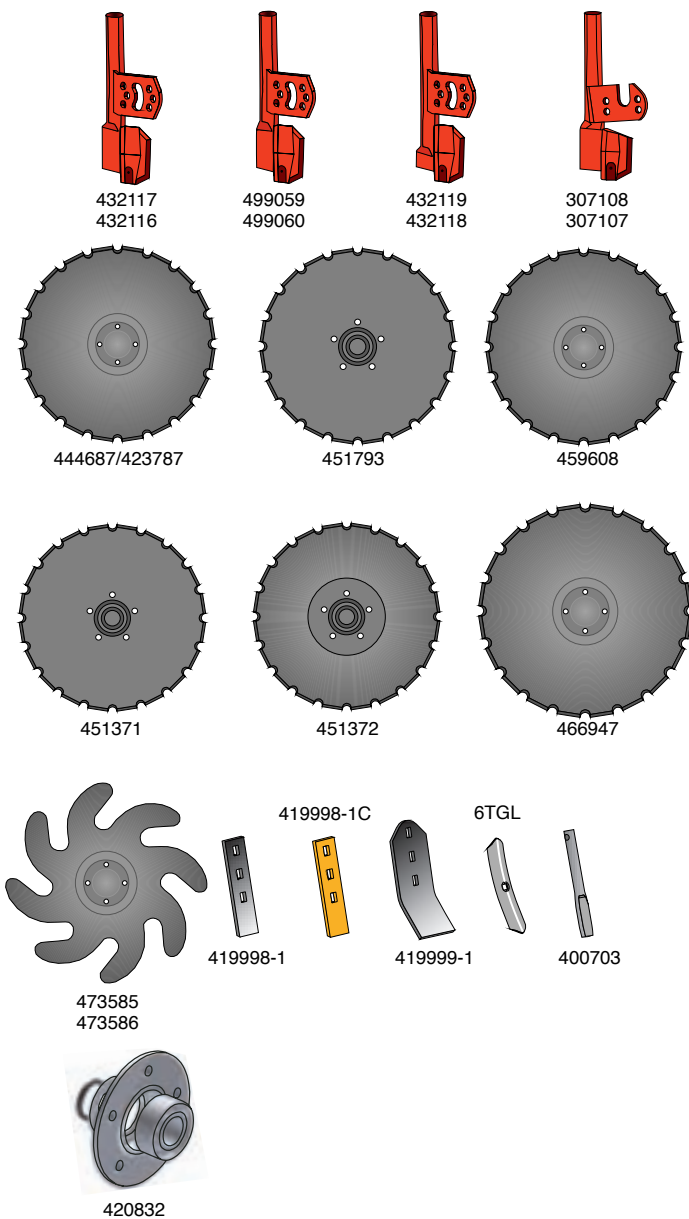

Article no.	Designation
432117	Seed share R
432116	Seed share L
499059	Bean share
499060	Bean share
432119	Seed share R, short slit
432118	Seed share L, short slit
307108	Seed share R
307107	Seed share L
444687 (423787)	Disc coulters, concave, notched Ø432mm
451793	Disc coulters, notched Ø370mm
459608	Disc coulters, concave, notched Ø432mm
451371	Disc coulters, notched Ø410mm
451372	Disc coulters, concave, notched Ø410mm
466947	Disc coulters, concave, notched Ø450mm
473585	Leveling disc L, Ø430mm
473586	Leveling disc R, Ø430mm
419998-1	Wearing plate 45x10mm
419998-1C	Wearing plate 45x10mm
419999-1	Wearing plate 80x8mm
6TGL	Rev. point 6 x 40 x 210mm
400703	Harrow point round Ø28 x 300mm
420832	Hub for disc coulters

Parts to fit:

# VÄDERSTAD subsoiler

## Guide boards, wings and points

Article no.	Designation	BK. no.
452956	Guide board R	BK148
461309	Guide board center	BK148
452957	Guide board L	BK148
457618	Point 50x12 mm	BK048
452854	Point 80x12 mm	BK048
452854C	EUROCARBIDE point 50x12mm	BK048
457618C	EUROCARBIDE point 80x12mm	BK048
155027	EUROPOINT 50x15mm	
155028	EUROPOINT 80x15mm	
447150	Wing R	
447151	Wing L	
334MOL	Rev. point, 16 x 60 x 490mm	BK034
335MOL	Rev. point, 12 x 80 x 420mm	BK034
336MOL	Rev. point, 12 x 100 x 420mm	BK034
337MOL	Rev. point, 10 x 120 x 455mm	BK034
338MOL	Rev. point, 10 x 130 x 485mm	BK034
339MOL	Rev. point, 12 x 100 x 480mm	BK034
201388-1	EUROPOINT R 90 x 10 x 460mm	BK044
201387-1	EUROPOINT L 90 x 10 x 460mm	BK044
447152	EUROPOINT rev. 20 x 50 x 495mm	
MLB498383/ MLB205006	EUROPINT with tiles	

Parts to fit:

# PÖTTINGER - seeder

## Disc

Article no.	Designation
8504.33.081.0	Seeding Disc, flat Ø380mm

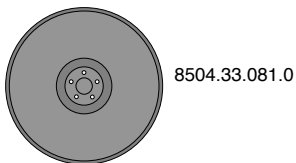



*Mølbro uses a specially developed welding wire imposed by welding robots to ensure optimal precision and uniformity.*

Parts to fit:

## AMAZONE harrow

### Disc

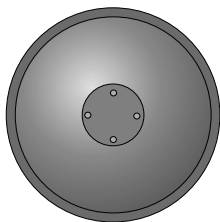

XL-041

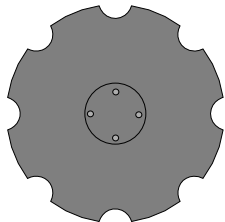

78201966

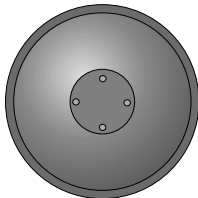

XL-011

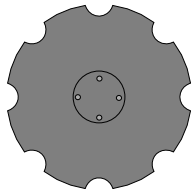

XL-043

Article no.	Designation
78201966	Disc couler, concave, notched, Ø510x4mm
XL-041	Disc couler, concave, plain, Ø510x4mm
XL-011	Disc couler, concave, plain, Ø460x4mm
XL-043	Disc couler, concave, notched, Ø460x4mm





**EUROCARBID**  
**Parts for ploughs**





**Hubs for discs**

Parts to fit:

## KVERNELAND

### Disc coulters and accessories



56156

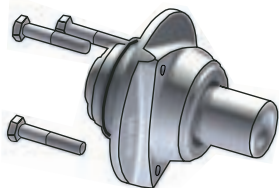

60609



56156

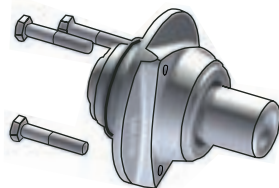

60624

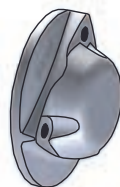

56156

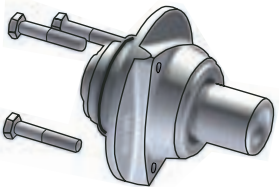

60609CA

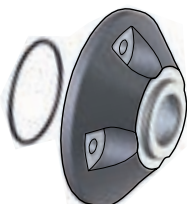

86100

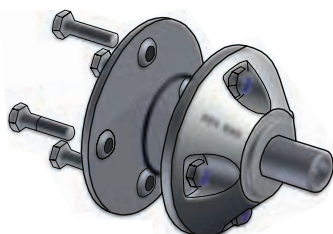

86087R

Article no.	Designation
56156	Universal cover for hub
60609	Hub disc coulters Ø34mm (complete)
56156	Universal cover for hub
60624	Hub disc coulters Ø30mm (complete)
56156	Universal cover for hub
60609CA	Hub disc coulters Ø30mm (complete)
86100	Hub for disc coulters (without axle)
86087R	Hub disc coulters (complete)

Parts to fit:

## VÄDERSTAD

### Disc coulters and accessories

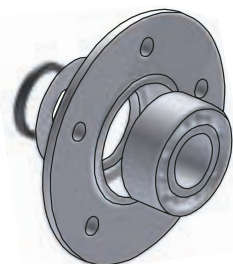

420832

Article no.	Designation
420832	Hub for disc coulters



Parts to fit:

# ÖVERUM

## Disc coulters and accessories

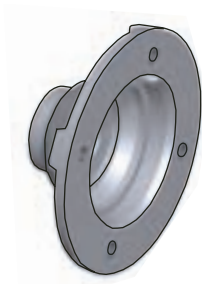

73249

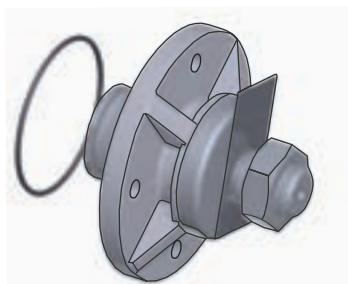

73242A

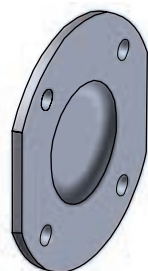

80966

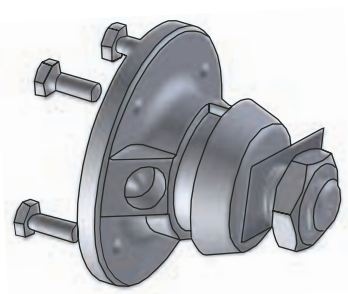

80967AH  
80967AV

Article no.	Designation
73249	Cover for hub
73242A	Hub for disc coulters 1/8" WGL
80966	Cover for hub
80967AH	Hub for disc coulters M30R
80967AV	Hub for disc coulters M30L



**BK System**

# MØLBRO BK's bolts and nuts System

BK. no.	Bolt kits pr. box	BK. no.	Bolt kits pr. box	BK. no.	Bolt kits pr. box
BK001	60	BK059	25	BK130	25
BK003	60	BK060	25	BK131	50
BK004	60	BK062	25	BK132	25
BK005	25	BK063	25	BK134	30
BK006	50	BK064	25	BK136	50
BK007	60	BK065	60	BK138	25
BK008	60	BK066	25	BK139	50
BK009	60	BK067	25	BK140	10
BK010	60	BK068	25	BK144	35
BK011	25	BK069	60	BK146	60
BK013	50	BK071	20	BK147	50
BK014	40	BK072	35	BK148	50
BK015	60	BK073	25	BK150	50
BK016	60	BK074	25	BK154	15
BK017	60	BK077	50	BK160	1
BK018	25	BK078	50	BK161	25
BK019	25	BK082	60	BK162	60
BK021	60	BK084	60	BK163	50
BK022	60	BK085	60	BK165	50
BK023	50	BK086	60	BK166	50
BK024	20	BK087	60	BK167	60
BK026	50	BK088	60	BK170	50
BK027	50	BK089	60	BK171	25
BK031	60	BK090	50	BK172	50
BK032	60	BK091	50	BK173	50
BK033	50	BK092	40	BK174	60
BK034	40	BK094	60	BK175	60
BK035	60	BK095	60	BK176	40
BK036	60	BK096	60	BK177	40
BK037	50	BK097	60	BK178	40
BK038	40	BK098	60		
BK039	35	BK099	60		
BK040	40	BK100	50		
BK041	60	BK101	60		
BK042	50	BK103	25		
BK044	50	BK104	50		
BK045	50	BK110	25		
BK046	60	BK111	60		
BK047	50	BK112	50		
BK048	60	BK113	40		
BK049	60	BK114	30		
BK050	60	BK116	10		
BK052	60	BK118	25		
BK053	60	BK119	60		
BK054	60	BK121	60		
BK055	50	BK122	60		
BK056	25	BK123	60		
BK057	40	BK128	40		
BK058	60	BK129	25		





# M7 PRODUCTS

Complete range – change the point with ONE stroke.

**MOL 4150/51**  
Lemken B, BS, US



**44879058**  
M7 wedge



**MOL612/613**  
Överum/Agrolux  
AH, AS, AX, XU, XL

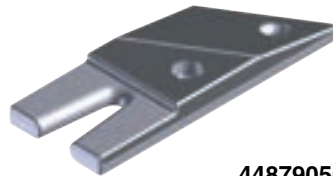

**44879056**  
M7 Pro-wedge



**MOL 83**  
Universal

**MOL 83-0/-1**  
Kverneland  
6, 7, 8, 9, 28

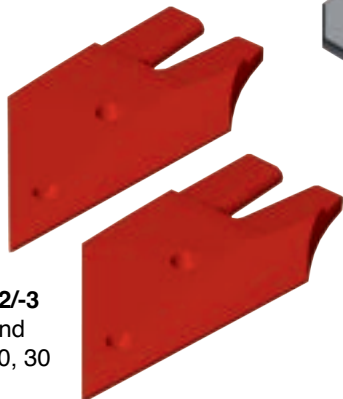

**MOL 83-2/-3**  
Kverneland  
12, 19, 20, 30



**MOL 25-0/-1**  
Kuhn H4, H6, HB



**MOL 30-0/-1**  
Kuhn SK

**MOL 20-0/-1**  
Kuhn VL, VS

*Made for hard work*



**Mølbro Production A/S**

Suserupvej 43

DK-4180 Sorø

☎ +45 57638400

✉ molbro@molbro.dk

**molbro.dk**